

Mk.123 TRANSMITTER/RECEIVER  
MANUAL

TECHNICAL PUBLICATION No. 82







MK. 123 TRANSMITTER/RECEIVER  
MANUAL

Part I contains Operating Instructions

Part II contains Technical Information

Either Part may be removed at the  
discretion of the Issuing Officer

TECHNICAL PUBLICATION NO. 82



TP82

Mk. 123 TRANSMITTER/RECEIVER

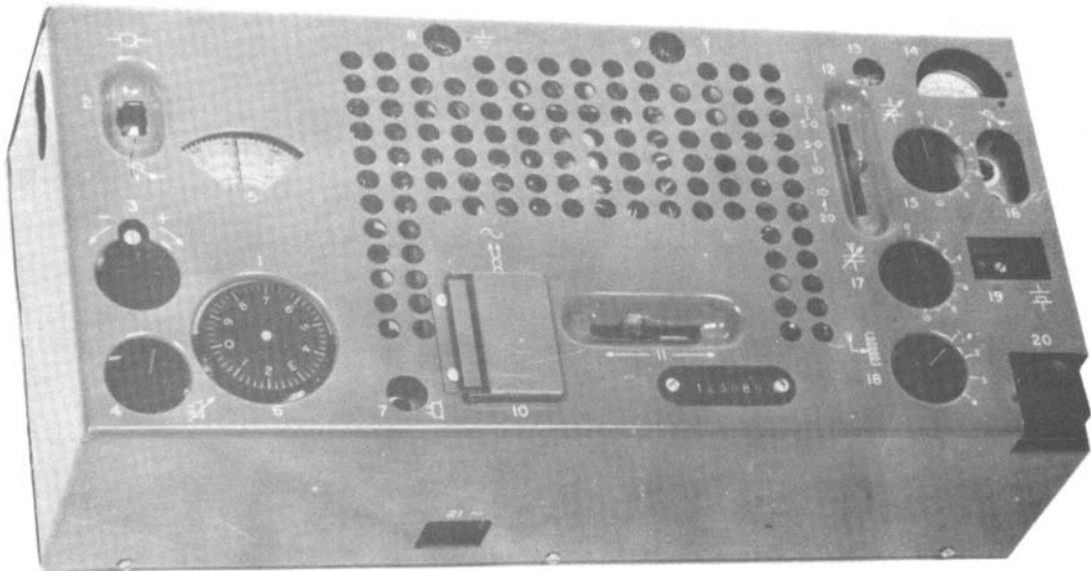

(Frontispiece)





Mk. 123

PART 1

OPERATING INSTRUCTIONS



PART: 1CONTENTS

<u>Section</u>		<u>Page</u>
1	ACCESSORIES AND SPARES .. ..	4
2	PHYSICAL DATA .. ..	5
2.1	Set only .. ..	5
2.2	Spares and Accessories .. ..	5
2.3	Complete Packed Equipment .. ..	5
3	GENERAL DESCRIPTION .. ..	6
3.1	Brief Description .. ..	6
3.2	Receiver Frequency Coverage .. ..	7
3.3	Transmitter Frequency Coverage .. ..	7
4	FUNCTION OF CONTROLS .. ..	9
5	OPERATING INSTRUCTIONS .. ..	11
5.1	Before connecting to the mains .. ..	11
5.2	The use of the Condenser Re-former .. ..	11
5.3	To Re-form Condensers .. ..	12
5.4	Setting the Voltage Selector .. ..	12
5.5	Connecting up the Equipment .. ..	14
5.6	To Receive a Station .. ..	14
5.7	Use of the B.F.O. .. ..	14
5.8	To Log a Station .. ..	15
5.9	Hand Generator Operation .. ..	17
5.10	12 volt Accumulator Operation .. ..	17
6	TUNING THE TRANSMITTER .. ..	19
6.1	Selection of Crystals .. ..	19
6.2	To Transmit on a Fundamental .. ..	19
6.3	To Transmit on the Second Harmonic .. ..	20
6.4	To Log the Transmitter Settings .. ..	21
6.5	Check Keying of Oscillator .. ..	21
6.6	Operational Notes .. ..	21
6.7	Examples of Transmitter Settings .. ..	22

CONTENTS  
(Continued)

<u>Section</u>		<u>Page</u>
7	AERIALS .. .. .	23
7.1	General .. .. .	23
7.2	Transmission from an Aerial Wire ..	23
7.3	Direction of Transmission .. ..	24
7.4	Aerial Planning .. .. .	29
7.5	Use of Insulators .. .. .	30
7.6	Other Accessories .. .. .	30
7.7	Aerial Layouts .. .. .	31
7.8	The Earth .. .. .	34
8	FAULTS AND REMEDIES .. .. .	36
8.1	General .. .. .	36
8.2	Receiver .. .. .	36
8.3	Transmitter .. .. .	38
8.4	Overheating of the Equipment ..	39

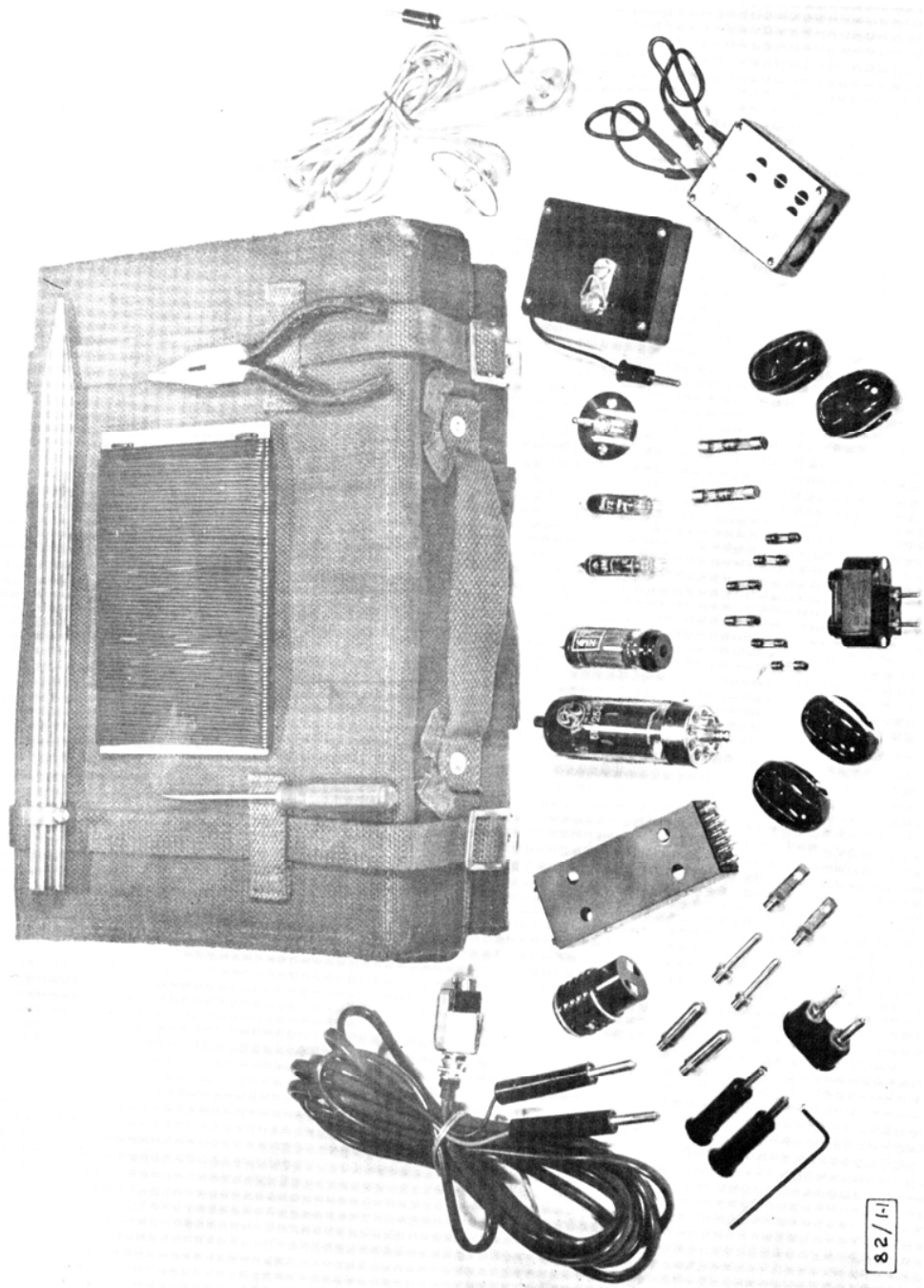

Accessories and Spares. Fig. 1-1

1

ACCESSORIES AND SPARES

See Fig. 1-1

<u>No. off</u>	<u>Description</u>	<u>Stock No.</u>
1	Receiver/Transmitter/Power Pack	123
1	Mains Lead Assembly (complete with Universal Mains Adaptor)	123-20
1	Crystal Adaptor Assembly	123-470
1	Plug 2-pin (for external key)	P201
1	Phones complete	H124J
1	Condenser Re-former	123-600
1	Transit Case	939D038
1	Valve 5A/163K	5A/163K
1	Valve CV428	CV428
1	Valve CV465	CV465
1	Valve CV466	CV466
6	Cartridge Fuses, 4 Amp. (miniature)	FC4M
4	Egg Insulators (small)	A100
1 pr.	Pliers (small)	W5440
1	Screwdriver (small)	W5703A
1	Neon Tester	1300/-
100	ft Wire 14/36 swg TC PVC covered black	K1074
1	Plate (on which aerial wire is wound)	383A034
1	Earth Rod and Ring	A254B
1	B8D Pin Aligning Tool	VB18A
2	Terminals (black)	P101B
1	Shorting Link	123H-70
1	Reel Aerial	1600/-
1	Allen Key 6BA	W5403
1	Canvas Carrying Case	969C015
2	Fuses, 15 Amp	FC15

PHYSICAL DATA2.1 Set only

Weight	7 lb 12 oz.	3.5 kg
Length	11 3/8 in.	29.9 cm
Height	3 3/8 in.	8.5 cm
Width	5 3/8 in.	13.6 cm

2.2 Spares and Accessories

12feet (4.2m) of twin core mains cable, plug adaptors, phones and crystal adaptors etc. as listed in section 1.

2.3 Complete Packed Equipment

The equipment is supplied in two Transit Cases - the Mk. 123 Transmitter/Receiver in one case and the Mk. 123 Spares Kit and canvas carrying case in the other. The two transit cases are provided with a polyetherfoam lining.

Mk. 123 TX/RX in Transit Case

Weight	19 lb 4 oz.	8.6 kg
Length	19 1/2 in.	49.5 cm
Height	12 1/2 in.	31.75 cm
Width	11 1/4 in.	28.75 cm

Spares Kit and canvas case in Transit Case

Weight	8 lb 12 oz.	3.97 kg
Length	15 1/2 in.	39.37 cm
Height	12 1/2 in.	31.75 cm
Width	7 in.	17.78 cm

## GENERAL DESCRIPTION

### 3.1 Brief Description

The Mk. 123 is a compact, portable Transmitter/Receiver operating in the waveband 2.5 Mc/s to 20 Mc/s (150 to 15 metres).

The receiver is a superheterodyne with a single radio frequency (RF) stage and is suitable for the reception of continuous wave (cw), modulated continuous wave (mcw) and telephony (rt) signals. On mcw it has a sensitivity of better than 10 microvolts for 10 dB signal to noise ratio and on cw signals the beat frequency oscillator (BFO) provides a gain of 15 dB at 1 Kc.

The transmitter is for cw only and can be hand keyed with the built-in morse key. An external hand key or mechanical keyer may also be used via the external key jack plug. Limitations to this use are:

(i) maximum keying speed of 40 wpm (due to 'Q' of the crystal)

(ii) keyer must accept the bias voltage of 135V.

The transmitter may be matched into any aerial likely to be used, and will deliver a power output ranging from 15 to 25 watts.

The power supply unit is in the same case, situated between the transmitter and the receiver. It is designed to operate from a supply of A.C. ONLY, 40-250 c/s. It has tapings every 10 volts between 100 and 150V and between 200 and 250V.

A re-former unit is available which enables the electrolytic capacitors to be re-formed after a period of storage.

In addition, an external power supply unit - the Mk. 123V - is available to operate the equipment from a 12 volt accumulator. A hand generator - the Mk. 810A - may also be used to power the Mk. 123 direct, or to charge a 12 volt accumulator via the Mk. 812A charging unit.



3.1 Cont. The equipment is suitable for use in ambient temperatures from 0°C to 45°C - and thus will operate satisfactorily under tropical conditions. Its use out of doors under tropical conditions or continuously under very high humidity conditions is not, however, recommended.

### 3.2 Receiver Frequency Coverage

<u>Band</u>	<u>Frequency coverage</u>
Band 1	2.5 - 5 Mc/s
Band 2	5 - 10 Mc/s
Band 3	10 - 20 Mc/s

### 3.3 Transmitter Frequency Coverage



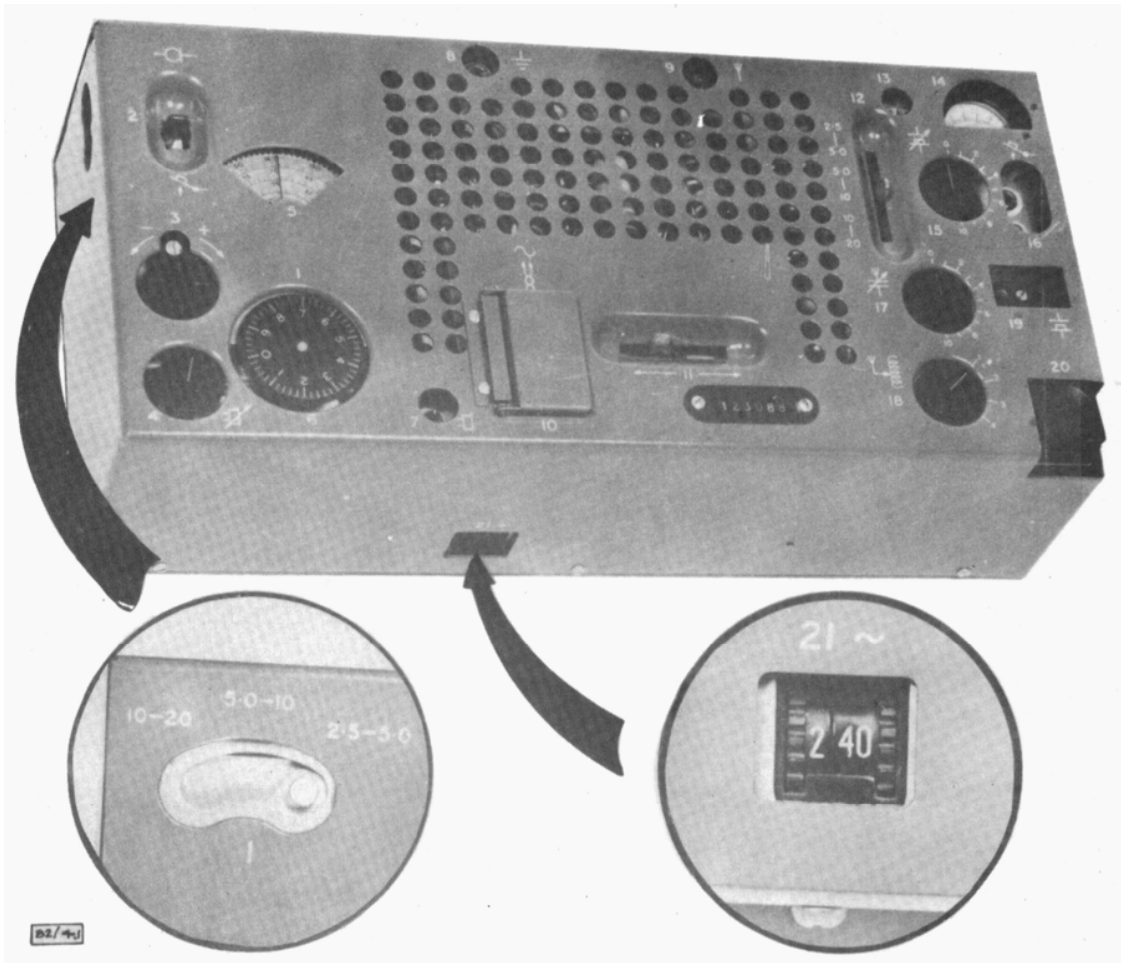

<u>Band</u>	<u>Frequency coverage</u>	<u>Power Output</u>
Band 1	2.5 - 5 Mc/s	19 - 25 watts
Band 2	5 - 10 Mc/s	15 - 25 watts
Band 3	10 - 20 Mc/s	13 - 25 watts



Controls - Fig. 4-1

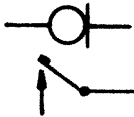
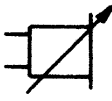





FUNCTION OF CONTROLS

All controls on the Mk. 123 are numbered and their functions are as follows:-

<u>No.</u>	<u>Symbol</u>	<u>Function</u>
1		Wave-Change Switch Receiver
2		Phone Beat-Frequency Oscillator (BFO) Switch Morse
3		BFO Tune
4		Gain Control
5		Receiver Dial
6		Tuning Knob
7		Phone Socket
8		Earth Socket
9		Aerial Socket
10		Power Input Plug

4  
Cont.

FUNCTION OF CONTROLS (Continued)

<u>No.</u>	<u>Symbol</u>	<u>Function</u>
11		Transmitter/Receiver Change-over Switch
12		Wave-change Switch - Transmitter
13		Drive Tuning Indicator Neon
14		Aerial Tuning Meter
15		Drive Tuning Knob
16		External Morse Key Socket
17		Power Amplifier (PA) Tuning Knob
18		Aerial Load Matching Switch
19		Crystal Socket
20		Morse Key (internal)
21		Mains Voltage Selector

These numbers are referred to within brackets throughout the Manual e.g. Gain Control (No. 4).

## CONFIDENTIAL

TP82

11

5

### OPERATING INSTRUCTIONS

#### 5.1 Before connecting to the mains

Ascertain the mains voltage and nature of supply - that is, alternating current (a.c.) or direct current (d.c.) - preferably by inspection of the Supply Meter or measurement with a reliable meter. A rough guide to the voltage and nature of supply can be made with the neon tester. Plug the two leads into the mains and compare the way the neons light up with the picture on the case.

Use the Electrolytic Condenser Re-former if the equipment has been in store.

#### 5.2 The use of the Electrolytic Condenser Re-former

If the equipment has been in store for a year or more (six months in a warm climate), the condensers will require re-forming - that is, the electrolytic dielectric insulation will have become insufficient and must be built up again. This can be done by applying a reduced voltage to the condensers. The leakage current will initially be quite high (because the insulation is inadequate) but will gradually fall (as the dielectric insulation becomes satisfactory). After an hour or two the condenser will be able to withstand the full voltage with negligible leakage current.

If this re-forming process were not carried out and the full voltage were applied to the condensers after a prolonged period of disuse, damage would occur to the condensers, and possibly to the rectifiers, by overheating due to the extra current being passed.

The Electrolytic Condenser Re-former is made in the form of a unit for insertion between the 18-pin mains plug and the equipment itself.

### 5.3 To Re-form Condensers

1. Set the mains selector to the same voltage as the a.c. supply (see section 5.4).
2. Insert the Condenser Re-former between the 18-pin plug and socket (No. 10) - see Fig. 5-1.
3. Switch (No. 11) to receive - to the left.
4. Insert the mains plug into the supply socket - a.c. ONLY.
5. Leave the set for two hours, then switch (No. 11) to transmit - to the right - and leave the set for a further period of two hours. The morse key should not be pressed during the re-forming process.
6. After this period the condensers should be satisfactory.
7. A rough check on the condition of the condensers can be made by observing the temperature of the re-forming unit after this period of processing:-

<u>Re-forming unit</u>	<u>Condensers</u>
cold	good condition - did not require re-forming.
warm	good condition - re-forming satisfactory.
hot or very hot	at least one condenser faulty - replace prior to use.

### 5.4 Setting the Voltage Selector

The voltage selector (No. 21) consists of two rotatable knurled edges. Rotate these edges until the correct voltage can be seen in the window. Care should be taken when handling equipment that the voltage setting is not accidentally altered.

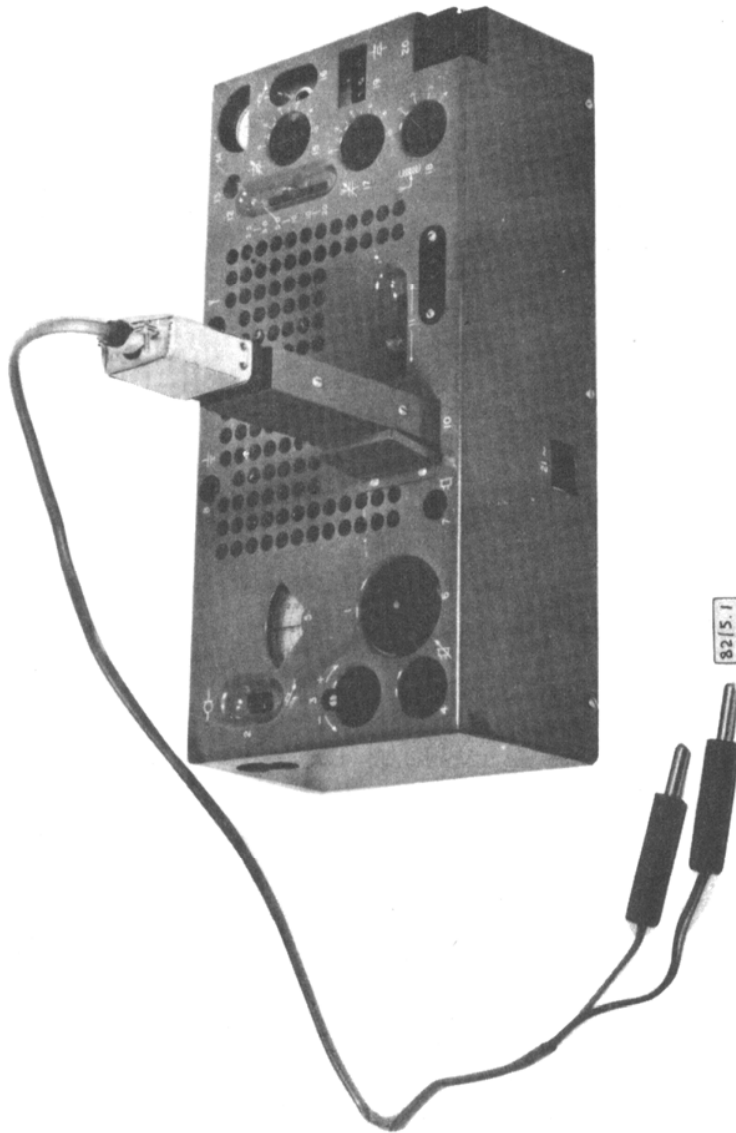

Condenser Re-Former in Position. Fig. 5-1.

### 5.5 Connecting up the Equipment

1. Select the mains plug pins to suit the power socket.
2. If the equipment has been unused or in store for twelve months (six months in a warm climate) or more, re-form the condensers as described in section 5.3.
3. Set the change-over switch (No. 11) to receive - to the left.
4. Connect the mains lead to the plug (No. 10).
5. Connect the aerial lead to socket (No. 9).
6. Connect the earth lead to socket (No. 8).
7. Connect the phones to socket (No. 7).
8. Connect to mains supply.

Note: For details of use with the Mk. 123V unit please refer to Technical Publication No. 95 Section 3.

### 5.6 To Receive a Station

1. Switch (No. 11) towards the receiver and allow the equipment to warm up for a few minutes.
2. Switch (No. 1) to the required waveband.

Band 1	2.5 - 5 Mc/s
Band 2	5 - 10 Mc/s
Band 3	10 - 20 Mc/s
3. Switch (No. 2) - the Beat Frequency Oscillator switch - to ON to receive morse signals or to OFF for speech or broadcast stations.
4. Set the BFO control (No. 3) to the central position.
5. Set the Gain control (No. 4) for a suitable level.
6. Search for the station to be received, on or near its frequency as shown on the dial (No. 5), using the tuning knob (No. 6). Calibration accuracy is 1% towards the centre of the scale and 0.2% at the alignment points at each end of the scale. To log a station refer to section 5.8.

### 5.7 Use of the B.F.O.

The B.F.O. has three main uses:-



5.7.1 To alter the tone of the morse signal

The BFO control is brought into operation by the BFO switch (No. 2). By rotating the knob (No. 3), the pitch or tone of a morse signal may be varied by as much as  $\pm 10$  Kc/s.

5.7.2 To find the carrier frequency of a station

Set the BFO tuning knob to its central position and tune the station with the main tuning control (No. 6) for zero beat or until a low pitched whistle is heard. This is the correct setting for that station and a log reading may be taken for future reference. If a broadcast station is being logged, do not forget to switch the BFO off after use.

5.7.3 To separate two interfering morse stations

The BFO may be used to separate two adjacent stations whose signals are so close together that neither can be read. Tune the unwanted signal to zero beat, or a very low pitched whistle. The wanted signal will rise in tone and be readable. Alternatively, the unwanted station may be tuned by the BFO to a very high pitch and so make the wanted signal more readable.

5.8 To Log a Station

When a particular station has been found and the Operator would like to return to that station, he may do so by using the Log Scale which is effectively 80 inches long.

This scale has twenty divisions on the dial (No. 5) and each division is further divided by the scale on the knob (No. 6) which has ten main divisions, each divided into five parts. Each part may be read to half a division which

CONFIDENTIAL

TP82

16

5.8 is 0.01 of the dial reading. It must be remembered  
 Cont. that these Log numbers are to enable the Operator to re-set the dial to a Station and must not be taken to represent the frequency or wavelength of that Station.

To take the Log number of a Station, make a note of a number lying under the cursor line on the dial (No. 5), to this number must be added the reading of the tuning knob (No. 6). The diagrams below show the receiver dials as they would appear on the set when taking a Log reading.

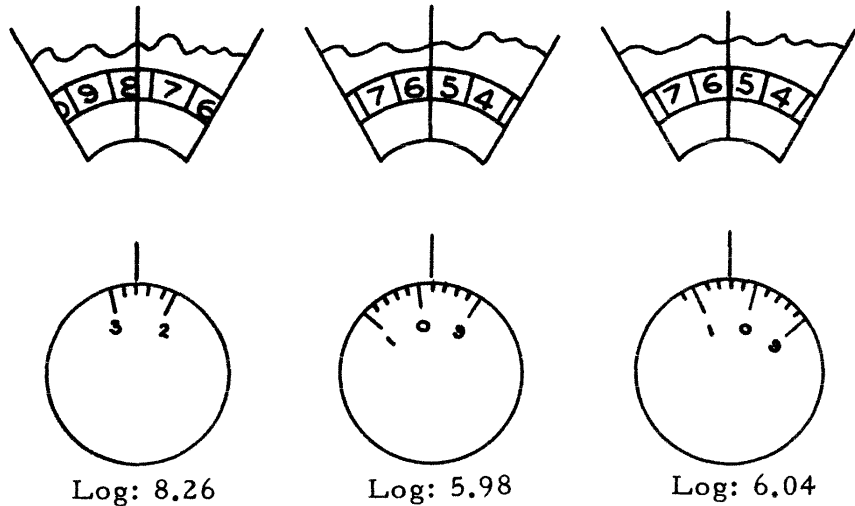

Care must be exercised whilst taking a Log reading when the cursor line is almost between two numbers on the dial (No. 5). The second example is sometimes incorrectly read as 6.98 but if you examine the two decimal figures .98 you will see that with a little more clockwise rotation of the knob (No. 6) the next figures will be 6.00 - 6.02 - 6.04 etc. So clearly the figure in front of .98 should be 5, making the correct Log reading 5.98.

### 5.9 Hand Generator Operation

The Mk. 123 may also be powered by the Mk. 810A hand generator. The mains voltage selector of the Mk. 123 should be set to 110 volts for operation on the hand generator.

The generator must be fixed in position by its clamps and then turned at approximately 65 r.p.m. keeping the meter reading between the two marks on the dial.

The output of the generator is approximately 110 volts 40 to 80 watts at 225 c/s.

Further details are available in Technical Publication No. 90.

### 5.10 12 volt Accumulator Operation

The Mk. 123 may also be powered by a 12 volt accumulator through the Mk. 123V inverter unit. Details are available in Technical Publication No. 95. The connections are illustrated in Fig. 5-2.

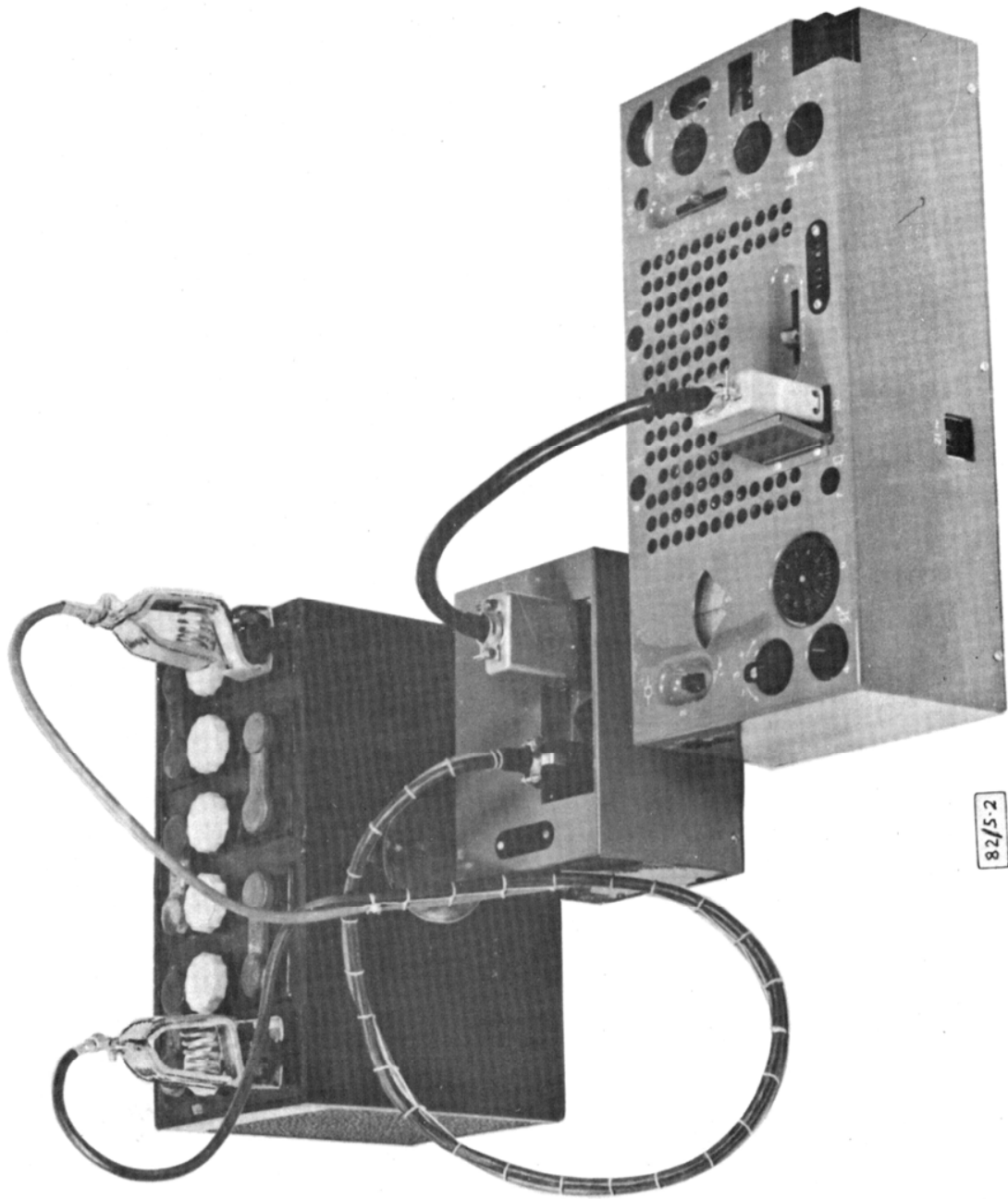

The Mk. 123V Connections. Fig. 5-2

TUNING THE TRANSMITTER6.1 Selection of Crystals

Where transmission is required on frequencies between 2.5/5 Mc/s the crystal will have a frequency equal to the transmission frequency. Where transmission is required between 5/10 Mc/s the crystal will have a frequency equal to the transmission frequency or one-half of the transmission frequency. Where transmission is required on frequencies between 10/20 Mc/s the crystal will have a frequency equal to one-half of the transmission frequency.

Crystals Style 'A', 'C' or Type FT, suitable for use in an oscillator circuit where crystal currents up to 60 milliamperes may be expected, may be used with the Mk. 123.

Equivalent parallel capacity of the oscillator: 30 pf.

Stability and temperature range of the crystals should be specified to suit the User's requirements.

6.2 To Transmit on a Fundamental, (crystal frequency)

1. For the purpose of this example, it is assumed that a crystal of 2.690 Mc/s is to be used.
2. Connect the aerial, earth and power cables as in section 5.5.
3. Set the Transmit/Receive switch (No. 11) to the right - i.e. towards the transmitter.
4. Plug the crystal into the socket (No. 19).
5. Set the Bandswitch (No. 12) to the waveband on which transmission is required, i.e. 2.5-5 Mc/s.
6. Press Key (No. 20).
7. Adjust the Crystal Tuning Knob (No. 15) for maximum illumination of the Neon (No. 13). If two tuning points are observed, take the lower dial reading as the fundamental.
8. Release Key (No. 20).

Note: After the key has been released and pressed again, it is occasionally found that the crystal does not re-commence oscillation - in which case a slight readjustment of the crystal tuning knob is required.

- 6.2 9. Set the Aerial Input Matching Switch (No. 18)  
Cont. to position 1.
10. Press the Key (No. 20).
11. Adjust the Aerial Tuning knob (No. 17) to obtain a maximum reading (No. 14). Compare this reading with those obtained with the switch (No. 18) in positions 2, 3 and 4. Release the key while the switch is being moved. Retune (No. 17) for maximum meter reading each time. Whichever switch position gives the highest possible meter reading is the best position - this represents the maximum transfer of power to the aerial at this frequency.

### 6.3 To Transmit on the Second Harmonic

1. The transmitter will 'double' on any crystal lying in the frequency range 2.5 to 10 Mc/s. For example, if a 7.120 Mc/s crystal is to be used, a signal can be sent out on 14.240 Mc/s - which is the second harmonic or double the crystal frequency.
2. The transmitter is set up as before but in this case the Bandswitch (No. 12) is set to the band covering the doubled frequency e.g. twice the crystal frequency of 7.120 Mc/s is 14.240 Mc/s - therefore use Band 10-20 Mc/s.
3. Press the Key (No. 20).
4. Adjust the Crystal Tuning knob (No. 15) for maximum illumination of the Neon (No. 13) - if two tuning points are observed, take the one occurring at the higher dial reading as the second harmonic.
5. Release the Key (No. 20) and continue as above - in sections 12.2.9 to 12.2.11.
6. It may happen, at certain frequencies, that two tuning points are observed whilst adjusting either the Aerial Tuning knob (No. 17) or the Crystal Tuning knob (No. 15). This occurs when both the fundamental and second harmonic frequencies appear within one waveband, e.g. a 5 Mc/s crystal will tune on 5 and 10 Mc/s on the 5-10 Mc/s waveband.

- 6.3 Cont. 7. It is possible to tune the P.A. (No. 17) to a harmonic of the drive frequency. This is undesirable as, in general, less power output is obtained. To obviate this, ensure that the P.A. tuning condenser (No. 17) and drive condenser (No. 15) are set to approximately the same relative positions when tuned. The bandswitch should be set to the range in which the required output frequency lies.

#### 6.4 To Log the Transmitter Settings

The setting of the control knobs for any given aerial and crystal may be logged to reduce the time required for transmitter tuning on subsequent occasions, i.e. note the crystal frequency, waveband and settings of controls Nos. 15, 17 and 18.

#### 6.5 Check Keying of Oscillator

If, after tuning as above, the transmitter will not 'key' (that is, the Neon (No. 13) will not re-strike), detune the drive tuning control (No. 15) a little and then complete the tuning procedure.

#### 6.6 Operational Notes when Tuning to the Second Harmonic

Care must be exercised when making a transmission on the second harmonic. Make sure that the bandswitch is set to the band that covers the second harmonic of the crystal in use.

Tune to that part of the band that you would expect the second harmonic to appear in, e.g. if a 6 Mc/s crystal is in use and a transmission is required at 12 Mc/s, tune to appropriate part of the 10-20 Mc/s band. That is, in this example, the lower end of the band - in order to avoid the third harmonic of 18 Mc/s at the higher end of the band.

6.6 Control knobs (Nos 15 and 17) are marked 1 to 10 as shown. The low frequency end is anti-clockwise while the high frequency end is clockwise. The figures 1 to 10 on the two knobs are arbitrary figures and must not be taken to represent specific frequencies.

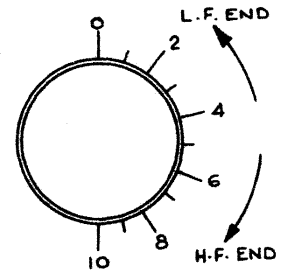

The position of control No. 17 may be influenced by the aerial matching switch (No. 18). If, after tuning up, the aerial matching switch (No. 18) is altered, re-check the setting of the aerial tuning knob (No. 17).

6.7 Examples of Transmitter Settings

TX on Freq Mc/s	Xtal in use - Mc/s	Drive Tuning	P.A. Tuning	Band Switch	Output Power Watts
2.5	2.5	0- 5	0- 5	2,5- 5	15
5.0	2.5	5-10	5-10	2,5- 5	
5.0	2.5	0- 5	0- 5	5,0-10	
5.0	5.0	5-10	5-10	2,5- 5	
5.0	5.0	0- 5	0- 5	5,0-10	
10.0	5.0	5-10	5-10	5,0-10	25
7.5	7.5	3- 7	3- 7	5,0-10	
15.0	7.5	3- 7	3- 7	10,0-20	
10.0	10.0	5-10	5-10	5,0-10	
10.0	10.0	0- 5	0- 5	10,0-20	
20.0	10.0	5-10	5-10	10,0-20	watts



## AERIALS

### 7.1 General

The efficiency of aerials, particularly within buildings, depends on many factors not easily measured or described. The following paragraphs include a simple description of the radiation of energy from aerials together with suggestions on how to erect aerials in a few selected circumstances. It is emphasised that the greatest efficiency is still obtained from an aerial of adequate length installed out of doors away from buildings or other tall objects. In particular, steel-framed buildings effectively screen the radiation from an aerial.

### 7.2 Transmission from an Aerial Wire

When current from the radio transmitter flows in the aerial wire, transmission occurs. The greatest transmission occurs where maximum current flows. The amount of current flowing varies along the length of the wire and is usually small in a short aerial. The greatest current flows some distance from the end of the wire. For convenience this distance will be called 'D'.

Figure 7-1 gives some idea of how transmission varies along the aerial wire when the wire is longer than distance 'D'. The distance 'D' for various transmission frequencies is shown in Table 7-1. Where the transmission frequency lies between the frequencies quoted, the approximate value for 'D' may be estimated. For example, for a transmission frequency of 6.8 Mc/s, the distance 'D' would be estimated as 35 feet (10 metres). Where a range of transmission frequencies is to be used, it will usually be best to select a value of 'D' corresponding to the lowest frequency. Aerials should have a length not much less than 'D', or longer than twice 'D'.

7.2  
Cont.

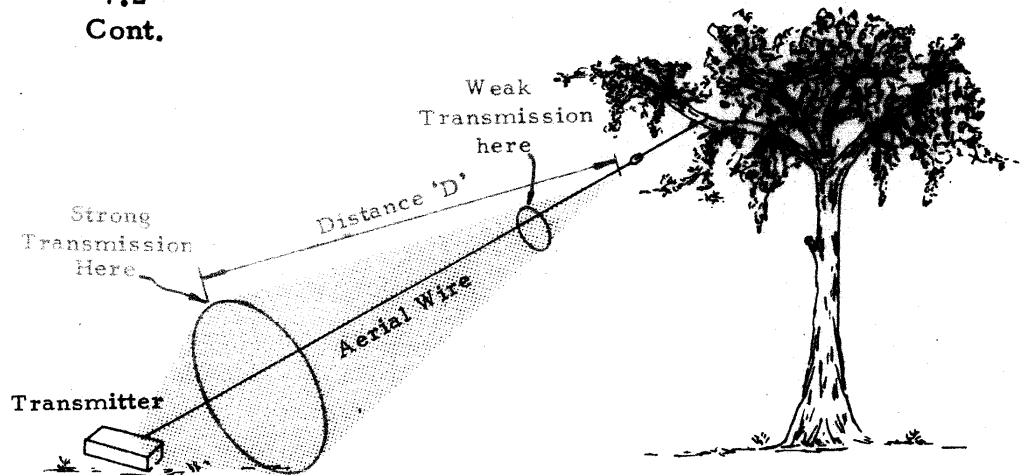

82/7-1

Long Wire Aerial  
Fig. 7-1

Frequency Megacycles	Distance "D"	
	Feet	Metres
2.5	94	29
3	81	24
3.5	67	20
4	61	18
4.5	54	16
5	47	14½
6	40	12
7	34	10
8	31	9
9	27	8
10	23	7
12	20	6
14	17	5
16	15	4½
18	13½	4
20	12	3½

Table 7-1

7.2      Fig. 7-2 shows the reduced transmission from  
Cont. a short aerial.

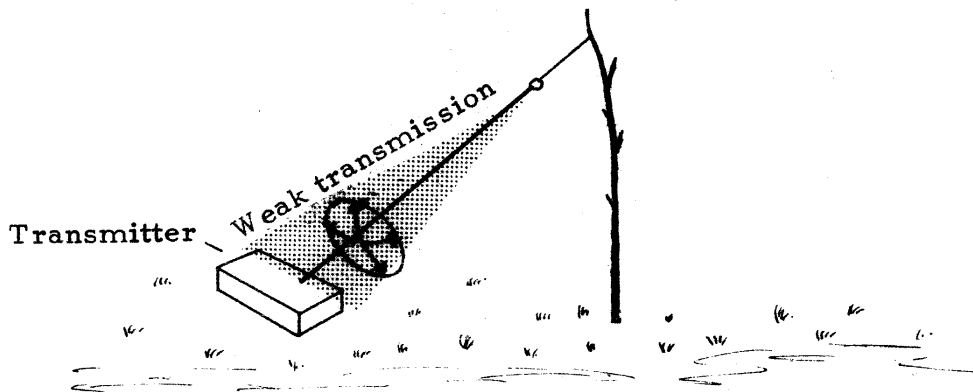

82/7-2

Short Wire Aerial  
Fig. 7-2

Figs. 7-1 and 7-2 show the radiation from straight wires. Frequently it will not be possible to erect a sufficient length of straight wire to obtain adequate radiation and the wire must be bent.

7.2  
Cont.

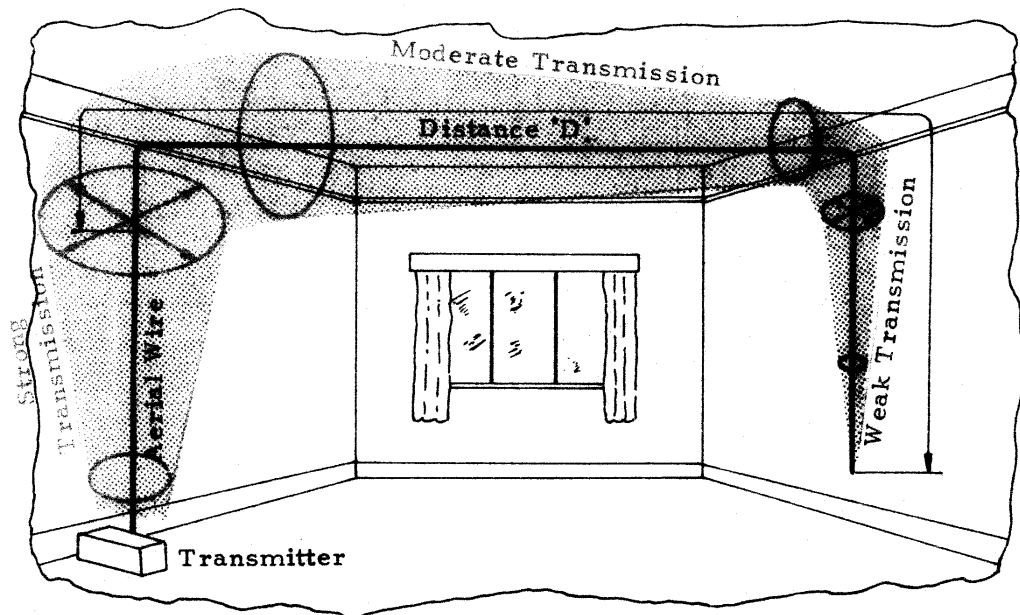

82/7-3

Aerial in Room  
Fig. 7-3

Fig. 7-3 shows how a wire of length slightly greater than 'D' may be taken round the walls and ceiling of a room. Maximum transmission occurs from the vertical wire to the left, with less transmission from the wire along the ceiling and opposite wall. The rings on the aerial as well as showing transmission strength show that the vertical wire sends signals towards the horizon whereas the horizontal wire sends signals upwards and sideways.

7.2 Looked at from near the end of the wire, radiation  
Cont. would appear as in Fig. 7-4.

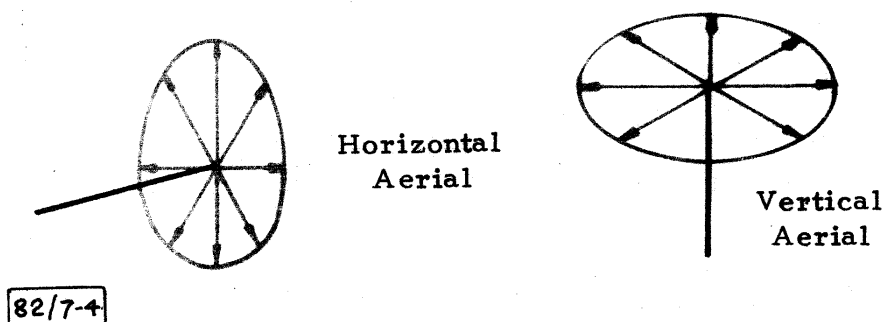

Aerial Radiations  
Fig. 7-4

This diagram looked at in conjunction with Fig. 7-3 shows how vertical parts of the aerial tend to send signals towards the horizon whereas the horizontal parts of the aerial tend to send signals towards the sky. Running the aerial wire alongside metal pipes, electric cables or similar objects should be avoided as transmission may be spoilt.

### 7.3 Direction of Transmission

To obtain the most efficient communication between two stations, it is not only necessary that signals be sent in the right direction, for example South-East, but also - depending upon the range of transmission - they should be sent at a low angle towards the horizon or at a high angle towards the sky.

Fig. 7-5 shows roughly the paths taken from a transmitter to receivers situated 80 km (50 miles), 500 km (300 miles) and 3000 km (2000 miles) away. It can be seen that signals should be transmitted at a

7.3 low angle (towards the horizon) if they are to reach a receiver 80 km (50 miles) away. The same signal unfortunately will fade out before reaching the receiver 3000 km (2000 miles) away.

To reach the second receiver 500 km (300 miles) away, signals must be sent high into the sky (high angle) where they are sharply reflected down again to the receiver.

Finally to reach receiver No. 3 at a very great range (3000 km, 2000 miles), the signal should be transmitted at a lower angle (towards the horizon).

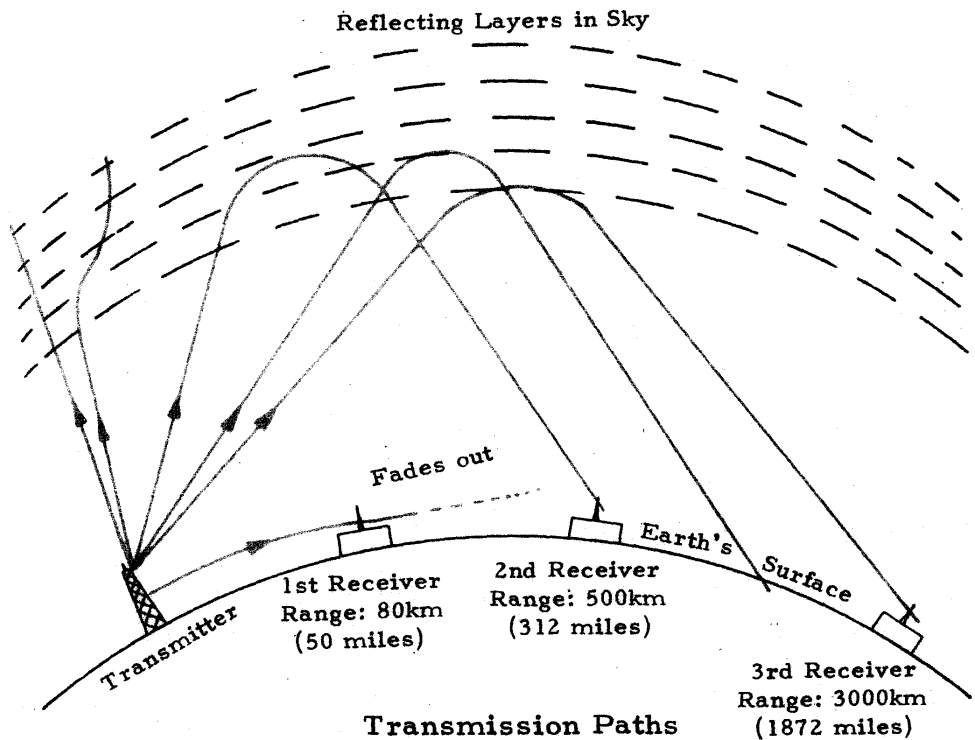

82/7-5

Transmission Paths  
Fig. 7-5

7.3 Cont. This information, together with that contained in previous sections, enables the user to arrange an efficient aerial where space permits. There will be many circumstances where the space available is much smaller than appears necessary to accommodate the wire. In such cases, the total length of wire should still not be much less than 'D', the spare wire at the end of the aerial being run backwards and forwards across a wall or ceiling. Typical aerials for use in difficult conditions are described in section 7.6.

#### 7.4 Aerial Planning

The following procedure is recommended:-

1. Refer to Table 7-1 and ascertain the distance 'D' corresponding to the lowest frequency to be used for transmission.
2. Knowing the range of communication, consider the importance of obtaining transmission at low angle (vertical wire) or high angle (horizontal wire) - also direction of transmission (from side of horizontal wire).
3. Examine the various possibilities of erecting aerial wire of length between 'D' (or slightly shorter) and twice 'D' having required transmission direction and angle.
4. Establish the best available earth system (see section 7.8 )
5. Using the available wire, connect the earth and erect the aerial.

### 7.5 Use of Insulators

The plastic covered wire supplied is insulated and, where string is used to attach the aerial to its supports, no further insulation is necessary. Where the end of the aerial wire is to be supported by another wire or metal object, use one of the egg insulators provided or interpose a length of string. The method of inserting an insulator may be seen in Fig. 7-6.

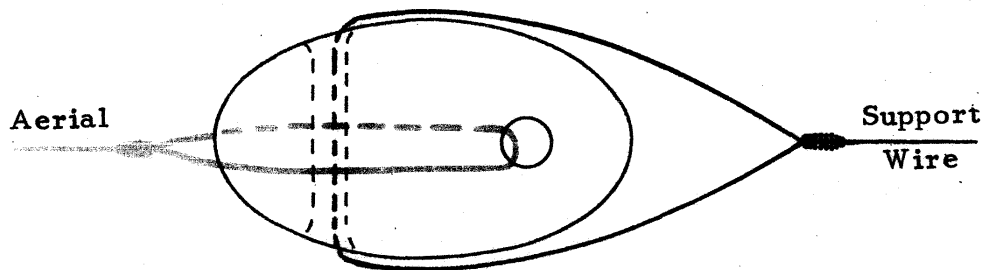

82/7-6

Egg Insulator  
Fig. 7-6

### 7.6 Other Accessories

When aerials have to be rigged and dismantled frequently, there are two useful accessories which may be purchased locally. One is a crocodile clip for connecting aerial and earth wires temporarily. The other is a hook with a suction cup which is useful for retaining an indoor aerial to doors, windows, picture rails etc.



7.7 Aerial Layouts

The following diagrams illustrate how to overcome the inconvenience of installing long aerials:-

7.7.1 Aerial in Room

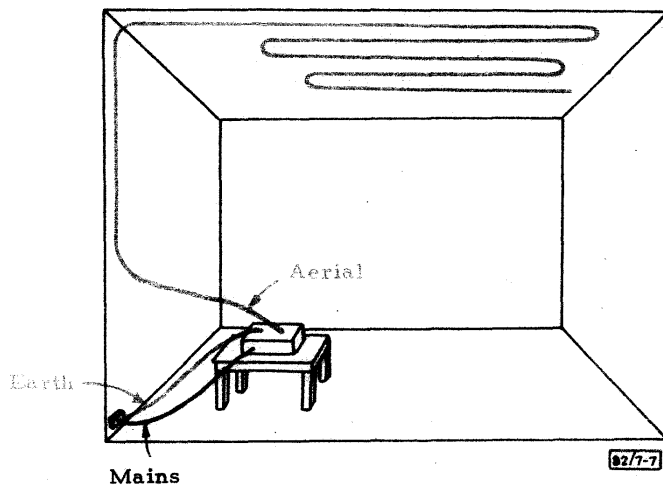

- Aerial Length 'D'
- Earth To mains socket
- Location Highest available room - no use in basement or cellar
- Radiation Mostly low angle, some high

Aerial in Room  
Fig. 7-7

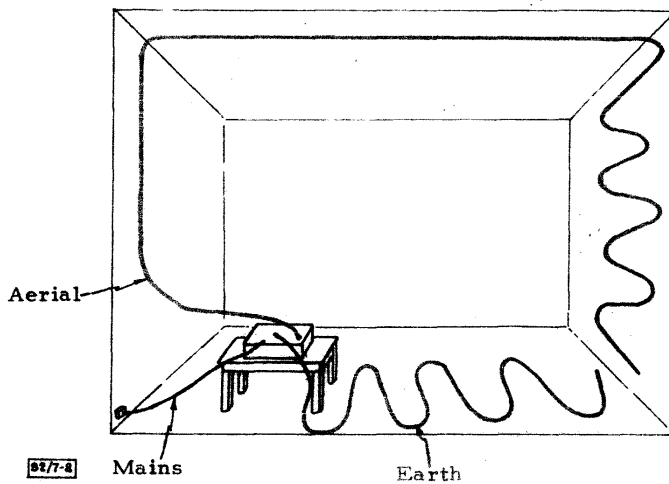

- Aerial Length 'D' or greater
- Earth Counterpoise
- Location Highest available room - no use in basement or cellar
- Radiation Low and high angle, more high angle than in Fig. 7-7

Aerial in Room  
Fig. 7-8

7.7 Cont. The transmissions from the aerials shown in Figs. 7-7 and 7-8 will vary with the position of the room in the building. The transmission from rooms on the upper floors will be greater than those from rooms on the ground or lower floors.

7.7.2 Aerial in Loft

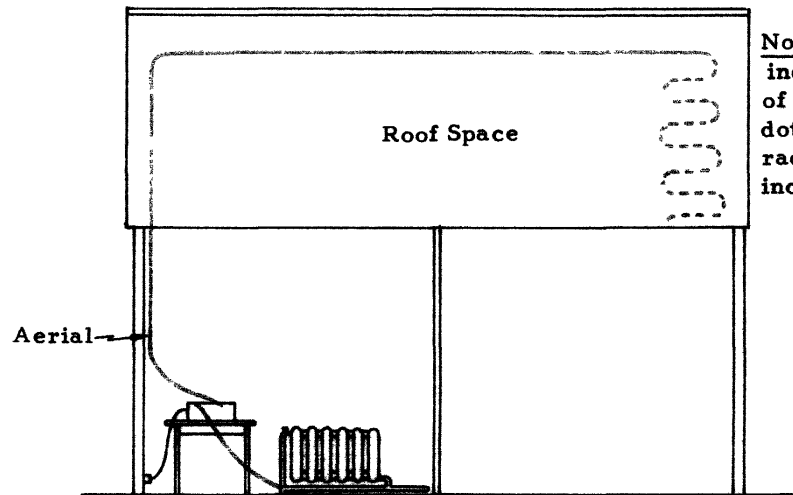

Note: By increasing length of aerial where dotted, high angle radiation may be increased.

Aerial	Length 'D'
Earth	Wire to central heating pipe
Location	Set in any room, aerial in loft
Radiation	Good low angle, moderate high angle, better than Figs. 7-7 & 7-8

82/7-9

Aerial in Loft  
Fig. 7-9

7.7 7.7.3 Aerial attached to Set in Basement  
 Cont.

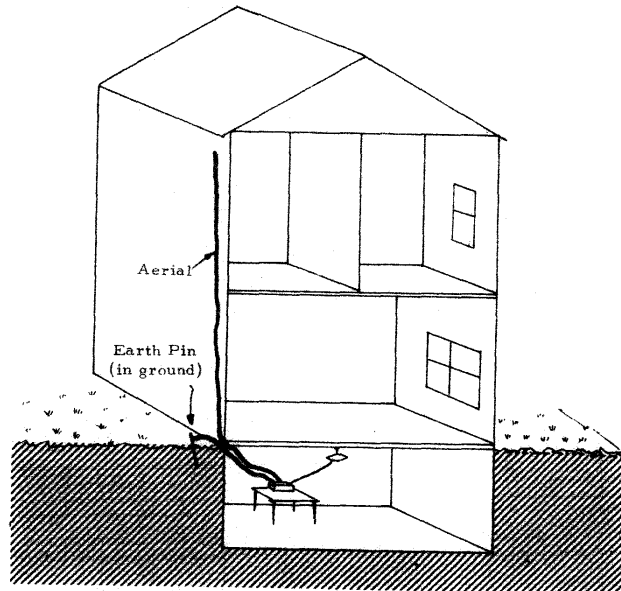

- |           |   |
|-----------|---|
| Aerial    | Wire on outside wall of house, length of wire outside is 'D' or greater |
| Earth     | Earth pin in ground   |
| Location  | Set in basement or cellar   |
| Radiation | Low angle   |

Aerial to Set in Basement  
 Fig. 7-10

With the transmitter situated in a basement room, the best plan is to run a vertical aerial up the wall of the building with the aerial and earth wires running close together below the ground level as shown in Fig. 7-10. When the building has a television aerial installed, the down lead and aerial may be used. The coaxial plug should be disconnected from the television receiver and the outer metal of the coaxial cable joined to the transmitter aerial terminal.

In an emergency, metal roof guttering may be connected to a wire down lead and used as an aerial. The down pipe is usually not much use in this respect as the sections are not usually properly joined together.

## 7.8 The Earth

The performance of an excellent aerial may be spoilt if the set is used with an inefficient earth. The earthing of a radio transmitter differs from the earthing of domestic electric appliances where earthing is necessary to protect the user from the risks of receiving a shock.

The most efficient earth comprises a large metal object buried in moist ground. The earth pin provided with the set will serve this purpose and should be joined to the earth terminal on the set by a short wire. It may not be possible to achieve this ideal and the following are recommended:-

- (i) connection to the cold pipe of a water supply system provided metal piping is used,
- (ii) connection to the earth wire of the electric system. Such an earth wire is usually present only where 3-pin plugs are in use.

In the event of the recommended earths not being available, and space permits, a 'counterpoise' earth may be used. The counterpoise earth should comprise a wire of length 'D' at the working frequency. Where a range of frequencies are used, 'D' should be chosen to correspond to the lowest frequency of the range. The counterpoise wire should be connected to the earth terminal of the set and stretched out as far as possible from the aerial wire. If space does not permit the counterpoise earth to be placed in a straight line, it may be bent in the same manner as the aerial, see Fig. 7-8.

If none of the foregoing prove practical, any accessible metalwork - such as central heating pipes or a metal building frame - may be used as an earth. The contact between the earth wire and metalwork - i.e. pipe, radiator etc. - should be a bare metal to metal joint. Connection to a gas system is not recommended as there is some risk of causing a fire.

7.8            Finally, where the transmitter is employed  
Cont.        with the mains power supply, the connection to the  
              mains provides some degree of earthing and will  
              permit transmission in the event of nothing better  
              being available. In this event, it is not necessary  
              to make any connection to the earth terminal of the  
              transmitter.

FAULTS AND REMEDIES8.1 GENERAL

Symptom: Set does not appear to function at all.

Remedy:

1. Check fuses in mains plug adaptors - there is one fuse in each lead. Replace, if necessary, with 15A fuses supplied with the spares.
2. Check fuse located on the underside of the set. Replace, if necessary, with a 4A fuse supplied with the spares.
3. Check pins on mains plug adaptor - they should be screwed up **finger tight**.
4. Check that the mains voltage tap switch (No. 21) is set correctly. Confirm voltage of mains supply with a meter or the neon tester.
5. Check that all connections are secure.
6. Check that the headphone jack plug is pushed right home.
7. Check that the small plugs that join the headphone leads to the earpieces are **seating correctly**.

8.2 RECEIVER

Symptom: A hiss is heard in the headphones, but the stations are not audible:

- Remedy:
1. Check other wavebands to see if the fault is present only on one particular band.
  2. Check the aerial.

8.2 Symptom: Broadcast stations are audible but no morse  
Cont. signals.

Remedy: 1. Listen for the extra noise which should be present when the BFO switch (No. 2) is switched on. If no change in noise level is heard, suspect the BFO.

Symptom: Reception is weak after the equipment has been stored for some time:

Remedy: 1. Check the aerial connections.  
2. Check the mains voltage setting.  
3. The electrolytic condensers may require reforming - see section 5.3.

Symptom: If nothing is heard, not even a hiss.

Remedy: 1. Follow procedure shown in section 8.1.  
2. Check that the valve retainer on V1 is not shorting the HT to the BFO switch.  
3. Check that the valve retainer on V3 is not shorting to the output jack socket P1.  
4. Check the HT, using a meter or the neon tester.  
5. With the cover removed, check that the stabilising valve V8 'strikes' when the set is switched (No. 11) to 'receive' position.

Valve changing should not be attempted until all the above measures have been taken. Valves V6 and V8 require workshop facilities and changing them in the Field is not practical.

8.3 TRANSMITTER

Symptom: The neon tuning indicator does not glow.

Remedy:

1. Follow procedure shown in section 8.1.
2. Check that the receive/transmit switch (No. 11) is switched to 'transmit'.

Symptom: The neon tuning indicator remains dull - does not glow to full brilliance.

Remedy:

1. Check for a faulty crystal by trying a substitute.
2. Check that the correct waveband is being used.
3. Check that the morse key is 'down'.
4. Change valve V1, using the 5A/163K valve supplied with the spares.

Symptom: The neon tuning indicator lights satisfactorily but the output meter fails to operate.

Remedy:

1. Replace valve V2 with CV428 valve supplied with the spares.

Symptom: The neon tuning indicator lights satisfactorily on tuning up, but fails to strike on subsequent keying.

Remedy:

1. Detune the drive (No. 15) - see section 6.2.8.



## 8.4 OVERHEATING OF THE EQUIPMENT

When the equipment is grossly overheated, smoke and/or an odour is usually apparent.

### SWITCH OFF IMMEDIATELY

There are three main types of odour:-

#### 8.4.1 Smell of Burning Rubber

If the aerial is grossly mis-matched, power will be dissipated in the aerial coil and the PA valve - and these two items will overheat. Since the valve is surrounded by rubber, a distinctive smell is produced. Check that the aerial is still connected to the equipment, retune the transmitter taking special care over the aerial matching and, if still overheating, lengthen the aerial in an effort to obtain more efficient transfer of power into it.

#### 8.4.2 Smell of 'Rotten Eggs'

A most unpleasant and unforgettable odour - produced when the rectifiers have overheated as a result of, usually, a faulty electrolytic condenser or other HT short to earth. Replacement of the rectifiers will be inevitable and tracing of the original fault is necessary before switching on again. A **rectifier** failure can also lead to a smell of hot varnish.

#### 8.4.3 Smell of Hot Varnish

Caused by an overheated mains transformer and is sometimes accompanied by heavy black smoke. Replacement of the mains transformer - requiring workshop facilities - is usually necessary. Do not switch on until the original fault has been found and corrected.

Overheating of the mains transformer can also be caused by a grossly incorrect voltage tapping or by inadvertant insertion of the equipment into d.c. mains supplies.



Mk. 123

PART 2

TECHNICAL INFORMATION

PART: 2  
CONTENTS

<u>Section</u>		<u>Page</u>
9	DESCRIPTION OF THE RECEIVER ..	42
9.1	General .. .. .	42
9.2	The Local Oscillator .. .. .	42
9.3	The I.F. Amplifier .. .. .	42
9.4	The Detector .. .. .	43
9.5	Beat Frequency Oscillator .. .. .	43
9.6	Audio Output Stage .. .. .	43
10	RECEIVER VALVE REPLACEMENT DATA	44
11	VALVE CHANGING .. .. .	45
11.1	V1, 2, 3, 4 and 5 .. .. .	45
11.2	V6 .. .. .	45
11.3	V7 .. .. .	46
11.4	V8 .. .. .	47
12	RECEIVER IF RESPONSE CURVE ..	49
13	RECEIVER AF RESPONSE CURVE ..	50
14	RECEIVER LIMITER ACTION .. ..	51
15	DESCRIPTION OF THE TRANSMITTER	52
15.1	General .. .. .	52
15.2	Transmitter Aerial Matching .. ..	53
16	TRANSMITTER VALVE REPLACEMENT	54
17	SIDE-TONE OSCILLATOR TRANSISTOR	54
18	POWER SUPPLY .. .. .	55
19	SIDE-TONE OSCILLATOR .. ..	56
19.1	General .. .. .	56
19.2	Side-Tone Oscillator Group Board ..	56
19.3	Side-Tone Oscillator Circuit .. ..	57
20	BLOCK DIAGRAMS .. .. .	58
20.1	Receiver .. .. .	58
20.2	Transmitter .. .. .	58

C O N T E N T S  
(Continued)

<u>Section</u>		<u>Page</u>
21	LOCATION OF COMPONENTS .. ..	59
21.1	Dust cores, trimming condensers & valves	59
21.2	Receiver Components .. .. .	60
22	RECEIVER PARTS LIST .. .. .	61
23	RECEIVER CIRCUIT DIAGRAM, ..	64
24	TRANSMITTER PARTS LIST .. ..	65
25	TRANSMITTER CIRCUIT DIAGRAM ..	67
26	POWER PACK PARTS LIST .. ..	68
27	POWER PACK CIRCUIT DIAGRAM ..	69
28	CONDENSER RE-FORMER CIRCUIT ..	70
29	RECEIVER TEST PROCEDURE ..	71
29.1	Equipment Required .. .. .	71
29.2	AF Gain .. .. .	71
29.3	IF Gain .. .. .	71
29.4	IF Bandwidth .. .. .	72
29.5	B.F.O. .. .. .	72
29.6	RF Sensitivity .. .. .	72
30	TRANSMITTER TEST PROCEDURE ..	74
30.1	Equipment Required .. .. .	74
30.2	Oscillator Alignment .. .. .	74
30.3	Aerial Tuning Meter .. .. .	74
30.4	Power Output .. .. .	74
30.5	Voltage and Current Measurements ..	75
31	POWER UNIT TEST PROCEDURE ..	77
31.1	Equipment Required .. .. .	77
31.2	Test Procedure .. .. .	77
31.3/8	Current and Voltage Readings ..	78
31.9	Side-Tone Oscillator .. .. .	79
31.10	Insulation .. .. .	79

## DESCRIPTION OF THE RECEIVER CIRCUIT

### 9.1 General

The receiver is a superheterodyne. The aerial is used both by the receiver and the transmitter. When the switch (No. 11) is toward the receiver, the aerial is connected to the tuning coils L1, L2 or L3 - according to which waveband the switch (No. 1) is set. The signal is amplified by V1 and then passes through a second stage of tuning L4, L5 or L6 - the primaries of which are damped by R2. The local oscillator signal is injected at this point.

### 9.2 The Local Oscillator

The local oscillator is of the tuned-grid type, g2 of V5 being used as the oscillator anode. L7, L8 and L9 are the oscillator coils. They are fitted with dust iron cores and adjustable trimming condensers C33, C34 and C35. The fixed padders are C32, C36/37 and C56. The oscillator HT voltage is stabilised by C46 with C31 as the RF bypass condenser. The local oscillator is at a higher frequency than the signal.

The local oscillator is electron coupled by the anode of V5 and is applied to the anode of V1, where it is fed into the grid of V2 the mixer valve, via the tuning circuits L4, 5 or 6.

### 9.3 The I.F. Amplifier

After mixing, the intermediate frequency of 465 Kc/s is applied to the IF transformer IFT1 which is tuned to 465 Kc/s. The signal is amplified by the IF amplifier valve V3 and then applied to the second IF transformer IFT2. C20 and C21 are neutralising capacitors giving the high gain IF amplifier a greater margin of stability.

#### 9.4 The Detector

V7 is the detector diode valve and at this point the Beat Frequency Oscillator voltage is applied from V6 to make c.w. signals audible.

#### 9.5 Beat Frequency Oscillator

The B.F.O. is of the electron-coupled Colpitts type and is coupled to the signal detector through a capacitor C40. The core of the inductance L10 is adjustable as in the IF circuits and a variation of several kilocycles above and below the intermediate frequency is obtained by the variable condenser C47 which is under the control of the operator (No. 3). Switch No. 2 on the front panel is the BFO on/off switch.

#### 9.6 Audio Output Stage

After being rectified by the detector V7, the signal passes through the IF filter C25, R15, C26 to remove any remaining IF frequency of 465 Kc/s. R14 is the diode load. The audio signal is then amplified by the valve V4 and is applied to the earphones via the miniature jack socket P1. Diodes W1 and W2 are crash limiters, that is, they reduce the amplitude of crackling, switch noises etc., and so protect the ears. The condenser C54 is to reduce the intensity of the very high frequencies, and prevent radiation of the IF via the phone leads.

RECEIVER VALVE REPLACEMENT DATA

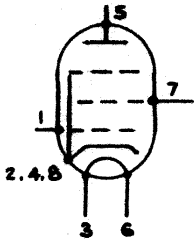
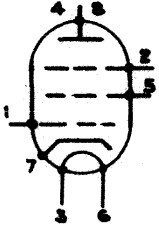
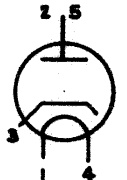
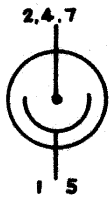
Valve	British Services	British Commer.	U.S. Equiv.	Base Connections
V1 V3 V5  Pentode	CV465	EF72		 <p>B8D/F</p>
V2 V4  Pentode	CV466	EF73		 <p>B8D/F</p>
V7  Diode	CV469	EA76		 <p>B5B/F</p>
V8  Stabiliser	CV4052	QS1202		 <p>B7G/F</p>



VALVE CHANGING

- 11.1 V1, V3 & V5 Pentodes (Spare: type CV465)  
V2 & V4 Pentodes (Spare: type CV466)

1. Remove the six Parker Kalon screws holding the case.
2. Remove the case.
3. With the small screwdriver or pliers provided, push the C-shaped retaining clip to one side and then remove the valve.
4. Before fitting the replacement valve, make sure that the valve pin wires are cut to the correct length -  $3/16$  in.  $\pm$   $1/32$  in. - and that they are perfectly straight by using the B8D pin aligning tool. This process is illustrated below.
5. Replace the valve.
6. Replace the retaining clip.
7. Replace the cover and secure with the six retaining screws.

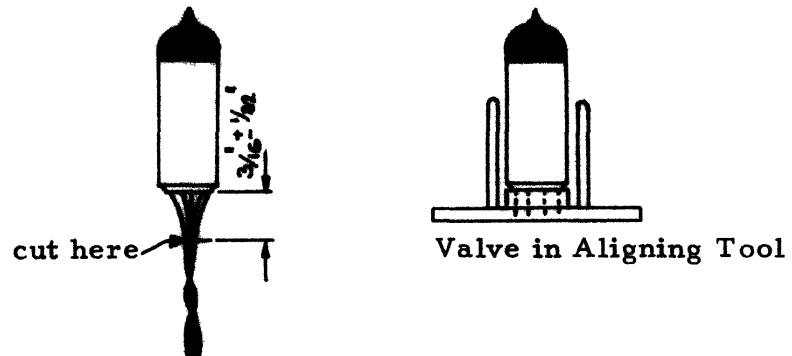

- 11.2 V6 B.F.O. Valve (Spare: type CV466)

This valve is situated inside the BFO unit and it is not recommended that any attempt be made to change it unless full workshop facilities are available.

If possible a complete replacement BFO unit should be fitted.

11.3 V7 Detector Diode (Spare: type CV469)

1. Remove the six Parker Kalon screws holding the case.
2. Remove the case.
3. Remove the four 2BA Phillips-headed screws on the back of the receiver.
4. Remove the three 4BA Phillips-headed screws on the back of the receiver.
5. Disconnect the earth (black) wire joining the power pack to the receiver.
6. Disconnect the six wires joining the power pack tag strip to the receiver tap strip.
7. Remove the receiver.
8. Push condenser C25 (on the IF transformer IFT2) on one side.
9. Remove valve V4.
10. Unsolder the two yellow V7 wires from the 3-way tag strip tag 5. See drawing below.
11. Unsolder the valve green wire from pin 3 of V4.
12. Unsolder the black wire from chassis E.
13. Lift the valve retainer and remove V7, drawing the two yellow wires and the green wire through the hole in the chassis.
14. Remove the sleeving from the old valve and replace on the new valve.

Green	Pin 1
Yellow	Pin 2
Black	Pin 3
Black	Pin 4
Yellow	Pin 5

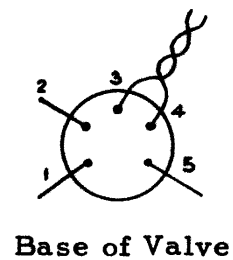

11.4 V8 Stabilising Valve (Spare: not provided)

1. Remove the six Parker Kalon screws holding the case.
2. Remove the case.
3. Remove the four 2BA Phillips-headed screws on the back of the receiver.
4. Remove the three 4BA Phillips-headed screws on the back of the receiver.
5. Disconnect the earth (black) wire joining the power pack to the receiver.
6. Disconnect the six wires joining the power pack tag strip to the receiver tag strip.
7. Remove the receiver.
8. Remove the three 4BA mushroom-headed screws from the centre of the bottom plate holding the gang condenser.
9. Remove the seven 6BA 3/16 in. mushroom-headed screws from around the edge of the bottom plate.
10. Remove the bottom plate.
11. Unsolder the two earth connections to the trimmers at the trimmer end.
12. Unsolder the condenser and wires on the rear gang section (BFO end).
13. Remove valve V2.
14. Tuck the three PVC wires out of the way of the soldering iron.
15. Unsolder the middle section and front section of the gang condenser, taking care not to mix up the wires on re-connecting.  
Middle section: one yellow wire to mixer switch.  
                  one yellow wire to C17, V2 pin 1.  
Front section: one yellow wire to osc. switch.  
Leave the yellow wire on the front section that goes to the condenser.
16. Unsolder the red wire, front of the tag strip which goes to V8 pin 5.
17. Remove the tuning condenser assembly by unscrewing the two 6BA  $\frac{1}{2}$ in. screws above the dial, taking care to note the position of the two washers under the dial block.

11.4  
Cont.

18. Remove the two 4BA Phillips-headed screws under the black vernier knob.
19. Withdraw the gang assembly from the front, taking care not to trap any wires.
20. Remove the condenser from the front gang C16 to obtain access to the earthing tag.
21. Unsolder the valve base wire with the black sleeve from the condenser frame (extra heat from a larger iron may be necessary to unsolder the earth joint to frame).
22. Prepare new valve by removing base wires 1, 2, 3, 6 and 7 completely.  
Put black sleeving on No. 4  
Extend No. 5 to 2 inches (5cm) long with tinned copper wire 26 swg and sleeve with red sleeving.
23. Replace the valve in spring retainer with black (pin 4) lead nearest to the point of earthing.
24. Make earth joint to condenser frame.
25. Replace condenser (C16).
26. Repeat operations as above in reverse order.

RECEIVER I.F. RESPONSE CURVE

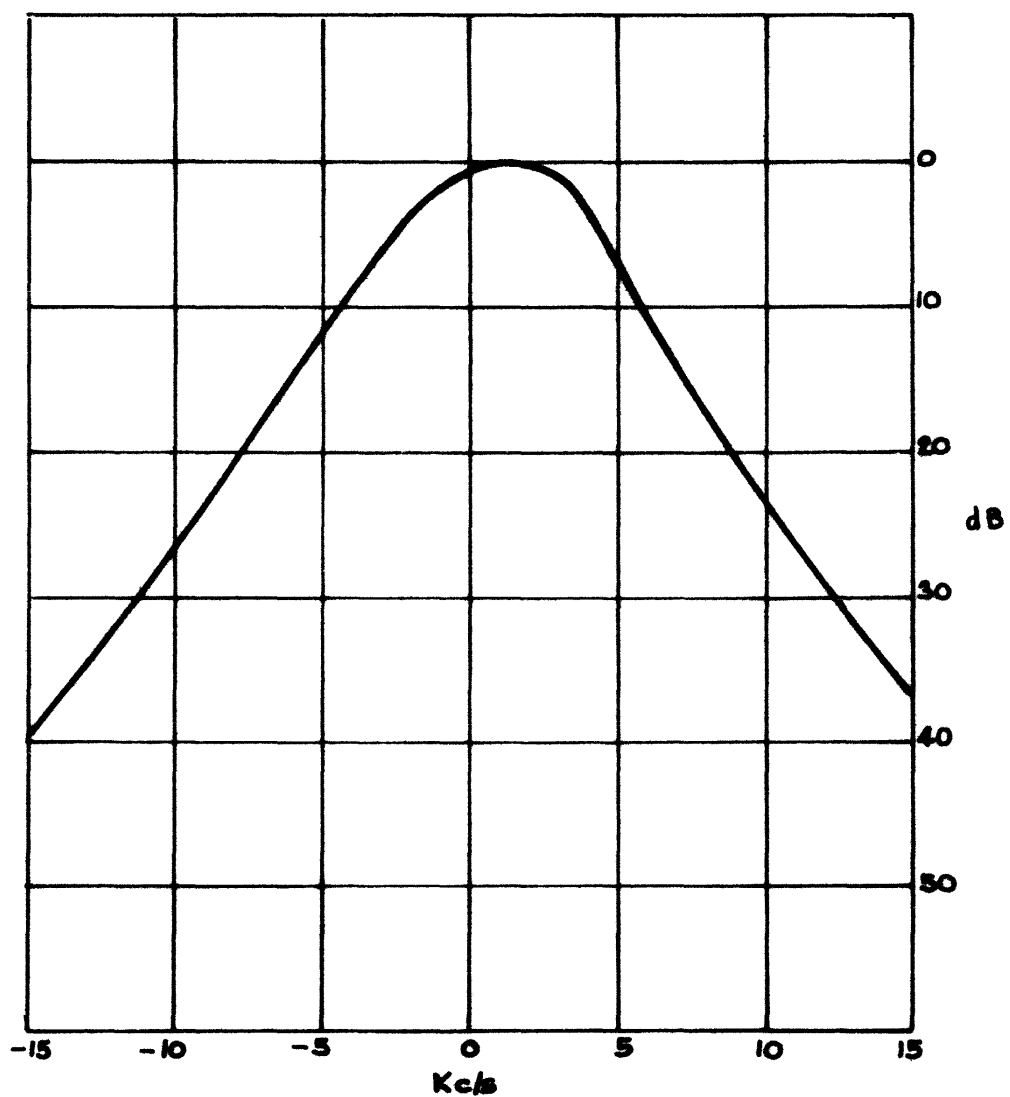

RECEIVER A.F. RESPONSE CURVE

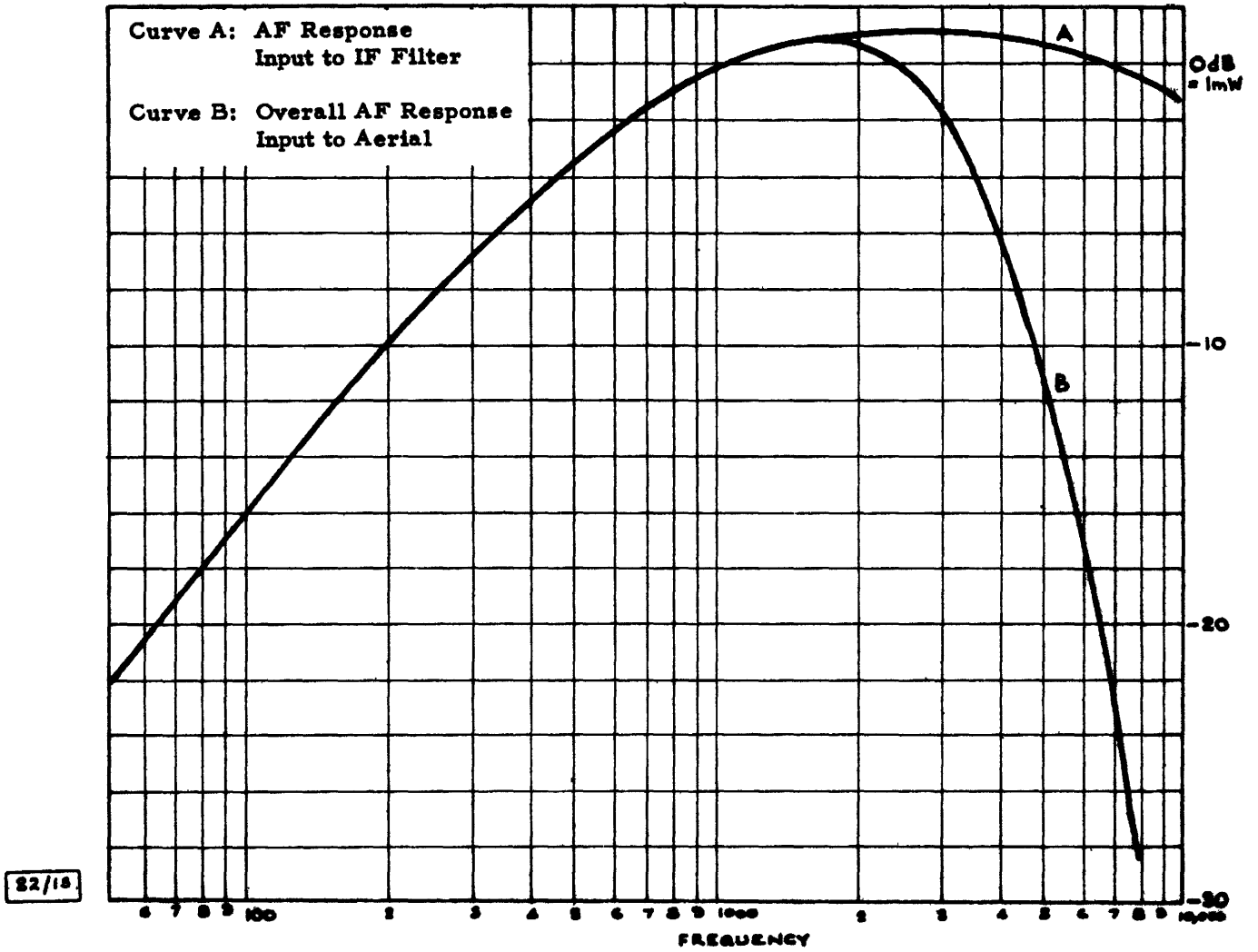

RECEIVER LIMITER ACTION

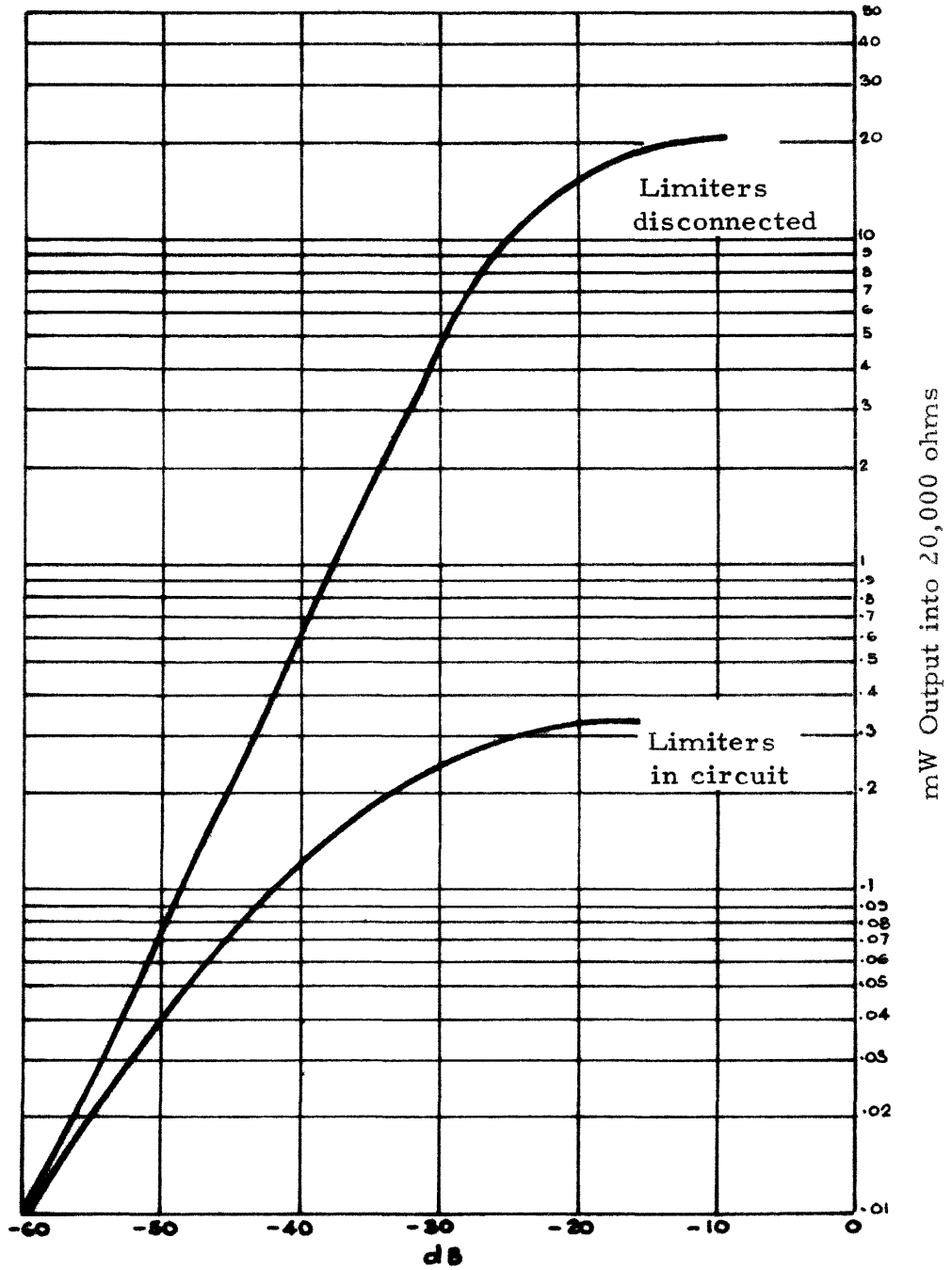

AF Input to TP2: at 1 Kc/s 0db=10 volts

15 DESCRIPTION OF THE TRANSMITTER CIRCUIT15.1 General

The transmitter will operate between 2.5 and 20 Mc/s in the following wavebands:-

Band 1	2.5 to 5.0 Mc/s
Band 2	5.0 to 10.0 Mc/s
Band 3	10.0 to 20.0 Mc/s

Valve V1 is a pentode performing two functions - that of oscillator and doubler. The oscillator electrodes are g1, g2 and cathode connected in a type of crystal controlled electron-coupled Colpitts circuit. Condensers C2, C3 and C4 are the feed back capacitors.

When the morse key is depressed, the bias is reduced thus bringing the crystal controlled oscillator into action. The capacitors C18 and C1 and resistor R2 are key click suppressors.

The coils L1, L2 and L3 are switched by S1A (No. 12) and tuned by the variable condenser C9 (No. 15) and these two controls can be tuned either to the fundamental or to the second harmonic (i.e. with a 4 Mc/s crystal, tune either to 4 Mc/s in Band 1 or to 8 Mc/s in Band 2).

The Neon LP1 (No. 13) is a resonance (or tuning) indicator for the drive frequency and glows to a maximum on tune.

The oscillator voltage is amplified by the power amplifier (P.A.) output valve V2. The resistor R9 and choke L4 are to suppress parasitics. After amplification, the signal has to be matched to the aerial so that the maximum power may be radiated. This is done by the anode tank coils L5, L6 and L7 tapped by switch S2 (No. 18) so that the aerial is properly matched. The coils are tuned by the variable condenser C13 (No. 17).



15.1        The meter M1 (No. 14) is the aerial voltage  
Cont. meter and part of the output is tapped off by the  
condenser divider C15 and C14, then rectified by  
RCT1 and smoothed by the RF filter condenser C16.

RCT2 provides an approximately logarithmic  
meter indication and is temperature compensated  
by Brimistor R-13.

## 15.2    Transmitter Aerial Matching Impedances

The aerial impedance matching switch has four  
positions and will match into the following loads:-

Tap 1	Optimum Load	25 ohms
Tap 2	Optimum Load	100 ohms
Tap 3	Optimum Load	500 ohms
Tap 4	Optimum Load	1,500 ohms

TRANSMITTER VALVE REPLACEMENT DATA

Valve	British Services	British Commer.	U.S. Equiv.	Base Connections
V1 HF Pentode	CV1635	5A/163K		<p style="text-align: right;">B9A</p>
V2 Beam Tetrode	CV428	5B/251M 5B/254M		<p style="text-align: right;">B8G</p>

SIDE-TONE OSCILLATOR TRANSISTOR REPLACEMENT DATA

Valve	British Services	British Commer.	U.S. Equiv.	Base Connections
VT1 Transistor	CV2400	OC71		

POWER SUPPLYMains Power Supply

The Power Supply will operate ONLY from a.c. supplies. The transformer is tapped at the voltages listed below.

Power Input Voltages, Current and Watts

50 c/s Input Volts	Receiver only		TX unkeyed		TX keyed	
	Amps	Watts	Amps	Watts	Amps	Watts
100	.44	31.5	.41	28.5	.92	83
110	.39	32.5	.36	29	.82	85
120	.37	33.0	.34	29	.76	86
130	.35	33.5	.32	29.5	.72	88.5
140	.33	33	.30	29.5	.67	88
150	.30	32.5	.28	28.5	.62	86
200	.23	33	.22	29	.48	89
210	.22	33	.21	29.5	.46	89.5
220	.21	33	.20	29	.45	89
230	.20	33	.19	29.5	.43	89
240	.20	33	.18	29.5	.41	88
250	.19	32	.18	29	.40	90

SIDE-TONE OSCILLATOR19.1 General

The side-tone oscillator provides an audible note in the operator's headphones when the transmitter is keyed.

It consists of a single stage transistor oscillator which derives its d.c. supply from the transmitter bias network. Reference to the circuit diagram shows that the transmitter bias is obtained from the voltage drop across the two resistors R3 and R4.

The voltage across R3 is negligible when the transmitter is unkeyed but rises to approximately 14 volts when keyed. This voltage is applied to the side-tone oscillator (connections A and B) and produces approximately 2 Kc/s tone, which is fed to the receiver headphones via connection C.

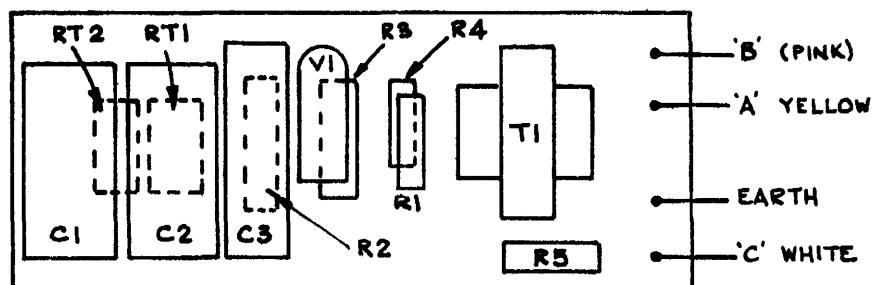
19.2 Side-Tone Oscillator Group Board

The group board is situated in the power supply section of the Mk. 123. Connections A, B and C connect to points A, B and C on the power pack.

19.3 Side-Tone Oscillator Circuit

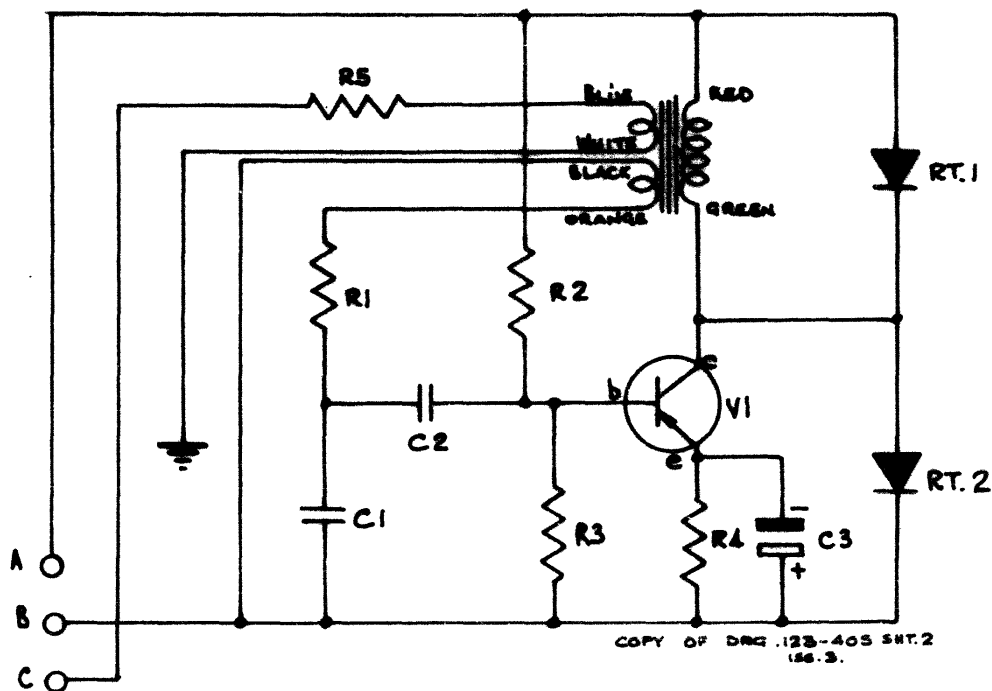

R1	Resistor	4.7 Kohm	+ 10%	Erie Type 16	R16/247K
R2	Resistor	15 Kohm	+ 10%	Erie Type 16	R16/315K
R3	Resistor	10 Kohm	+ 10%	Erie Type 16	R16/310K
R4	Resistor	1.5 Kohm	+ 10%	Erie Type 16	R16/215K
R5	Resistor	470 Kohm	+ 10%	Erie Type 16	R16/447K
C1	Condenser	.1 $\mu$ F	+ 25%	Dubilier 412	CT101D
C2	Condenser	.1 $\mu$ F	+ 25%	Dubilier 412	CT101D
C3	Condenser	8 $\mu$ F	+50% -25%	TCC 68A/D	CE8TP/W
RT1	Miniature Westector Type W				RT6A
RT2	Miniature Westector Type W				RT6A
V1	Transistor OC71				RT222
T1	Transformer				TL368

BLOCK DIAGRAMS

20.1 Block Diagram - Receiver

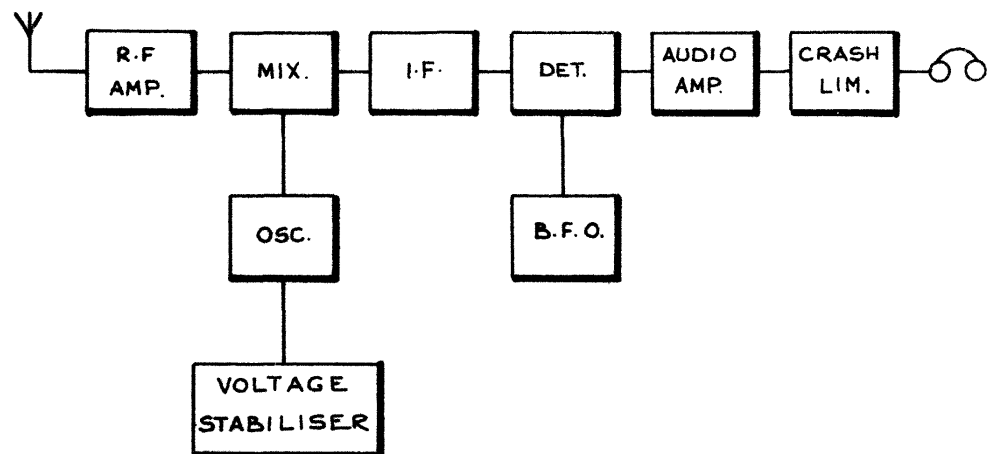

20.2 Block Diagram - Transmitter

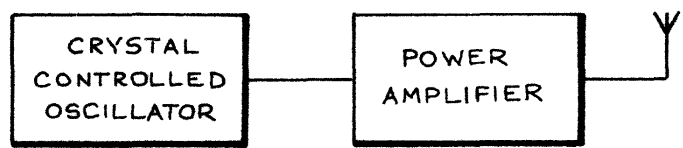

LOCATION OF COMPONENTS

21.1 Location of iron dust cores, trimming condensers and valves

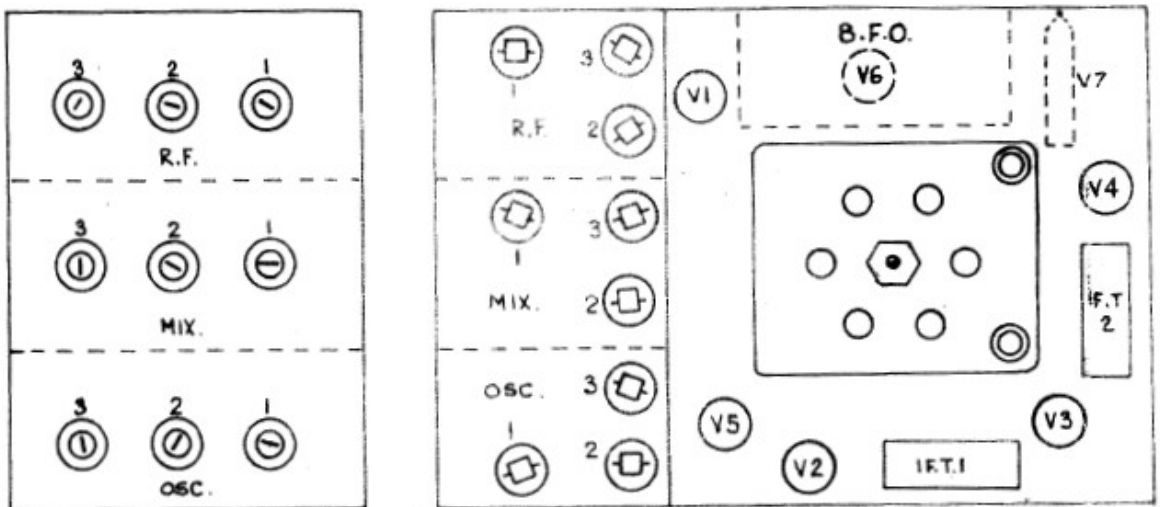

42/21.1

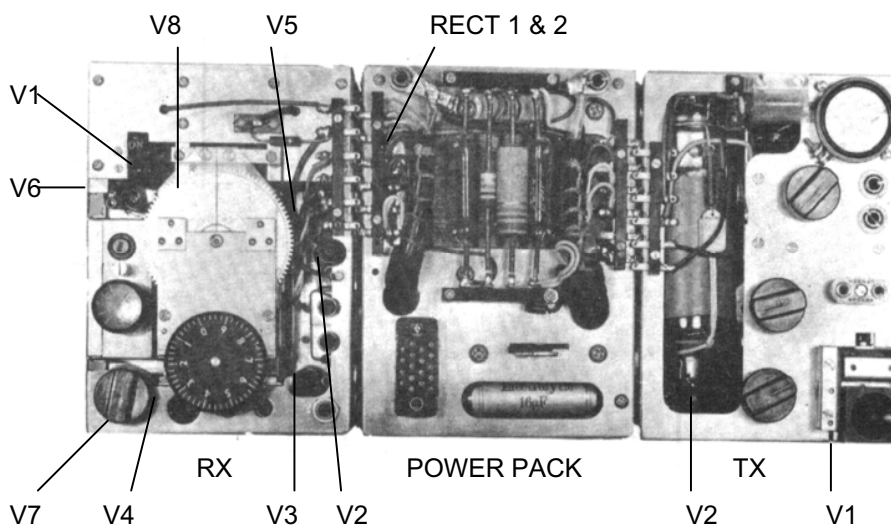

21.2 Receiver Components

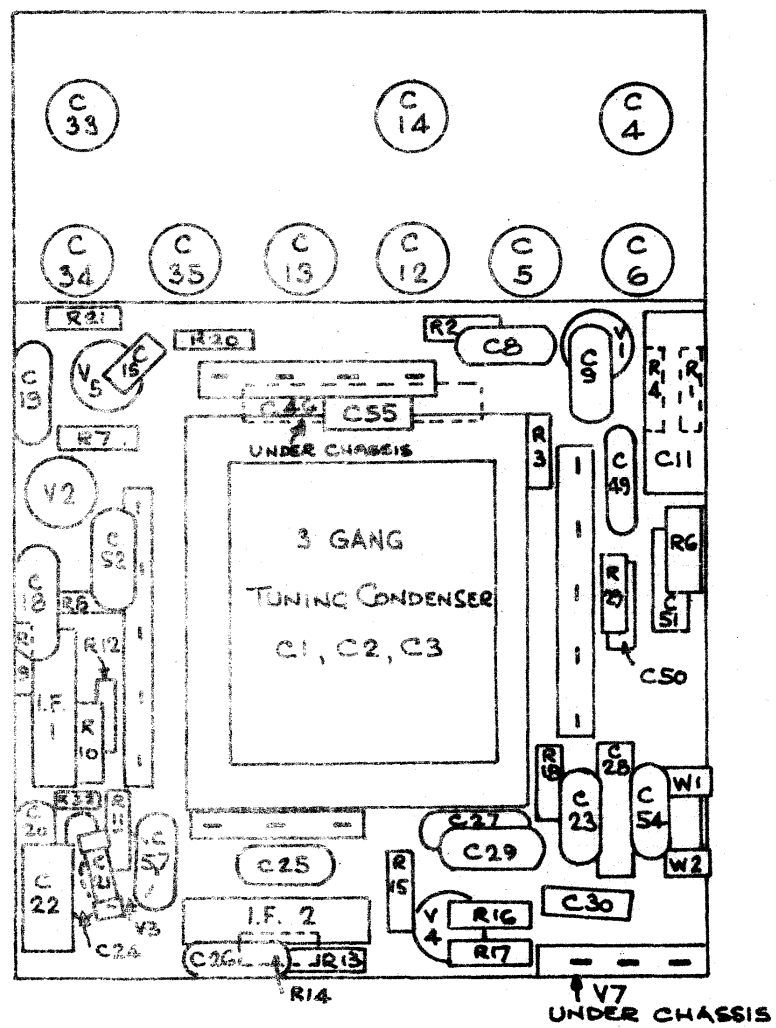



RECEIVER PARTS LIST

<u>Circuit</u> <u>Ref. No.</u>	<u>Value</u>	<u>Description</u>	<u>Stores</u> <u>Ref. No.</u>	<u>Circuit</u> <u>Location</u>
R 1	3.9 Kohms	1/4watt +10% Erie type 16	R16-239-K	B4
R 2	10 Kohms	1/4watt +10% Erie type 16	R16-310-K	D4
R 3	1 Kohm	1/4watt +10% Erie type 16	R16-210-K	B5
R 4	180 ohms	1/4watt +10% Erie type 16	R16-118-K	F5
R 5	5 Kohms	2 watt potentiometer Painton CV2	RW-35-P	F5
R 6	82 Kohms	1/2watt +10% Erie type 9	R9-382-K	E7
R 7	1 Mohm	1/4watt +10% Erie type 16	R16-510-K	F8
R 8	47 Kohms	1/4watt +10% Erie type 16	R16-347-K	B8
R 9	1 Kohm	1/4watt +10% Erie type 16	R16-210-K	B9
R 10	470 Kohms	1/4watt +10% Erie type 16	R16-447-K	E10
R 11	1 Kohm	1/4watt +10% Erie type 16	R16-210-K	B11
R 12	180 ohms	1/4watt +10% Erie type 16	R16-118-K	F11
R 13	47 Kohms	1/4watt +10% Erie type 16	R16-347-K	D13
R 14	470 Kohms	1/4watt +10% Erie type 16	R16-447-K	F14
R 15	1 Mohm	1/4watt +10% Erie type 16	R16-510-K	F15
R 16	470 Kohms	1/4watt +10% Erie type 16	R16-447-K	B15
R 17	100 Kohms	1/4watt +10% Erie type 16	R16-410-K	B15
R 18	470 ohms	1/4watt +10% Erie type 16	R16-147-K	F15
R 19	27 Kohms	1/4watt +10% Erie type 16	R16-327-K	J2
R 20	33 ohms	1/4watt +10% Erie type 16	R16-033-K	H7
R 21	22 Kohms	1/4watt +10% Erie type 16	R16-322-K	J7
R 22	150 Kohms	1/4watt +10% Erie type 16	R16-415-K	H13
R 23	220 Kohms	1/4watt +10% Erie type 16	R16-422-K	H14
R 24	100 Kohms	1/4watt +10% Erie type 16	R16-410-K	J14
R 25				
R 26				
R 27				
R 28	1 Mohm	1/4watt +10% Erie type 16	R16-510-K	F4
R 29	100 ohms	1/4watt +10% Erie type 16	R16-110-K	F8
R 30	10 Kohms	1/4watt +10% Erie type 16	R16-310-K	K13
R 31	33 Kohms	1/4watt +10% Erie type 16	R16-333-K	F4
R 32	470 ohms	1/4watt +10% Erie type 16	R16-147-K	E11

22  
Cont.

RECEIVER PARTS LIST (Continued)

<u>Circuit</u> <u>Ref. No.</u>	<u>Value</u>	<u>Description</u>	<u>Stores</u> <u>Ref. No.</u>	<u>Circuit</u> <u>Location</u>
C 1 (				F4
C 2 (	200 pF	3-gang tuning condenser Jackson	C3200F	F8
C 3 (				J6
C 4 (				F2
C 5 (	5-30 pF	Erie Style 557N750	CX430F	F3
C 6 (				F3
C 7				
C 8	.001 uF	+20% Dubilier type 400	CT0013	B5
C 9	.001 uF	+20% Dubilier type 400	CT0013	E4
C 10				
C 11	.1 uF	+20% Hunts type W48	CT101H/A	F5
C 12 (				C5
C 13 (	5-30 pF	Erie Style 557N750	CX430F	C6
C 14 (				C7
C 15	4 pF	+ $\frac{1}{2}$ pF Erie Style KA Gimmicon	C540D	F6
C 16	10 pF	+5% Erie Ceramicon N750K	C410AJ	F8
C 17	100 pF	+20% Dubilier type 400	CT001/1	E8
C 18	.001 uF	+20% Dubilier type 400	CT0013	C9
C 19	.001 uF	+20% Dubilier type 400	CT0013	C8
C 20	750 pF	+10% Dubilier type S635	CS375DK	E10
C 21	1.5 pF	+1/4 pF Erie Style EKA Gimmicon	C515E	D11
C 22	.01 uF	+20% Hunts type W99 B810	CT013J	F11
C 23	.01 uF	+20% Dubilier type 400	CT011	F11
C 24	.02 uF	+10% Plessey Plesmin	CT021P/K	F12
C 25	100 pF	+20% Dubilier type 400	CT001/1	F13
C 26	100 pF	+20% Dubilier type 400	CT001/1	F14
C 27	.01 uF	+20% Dubilier type 400	CT011	D14
C 28	8 uF	-25% +50% TCC type CE68A/D	CE8TP/W	F15
C 29	.005 uF	+20% Dubilier type 400	CT0052	C15
C 30	.01 uF	+20% Hunts type W99 B810	CT013J	D16
C 31	.005 uF	+20% Dubilier type 400	CT0052	K2
C 32	.0013 uF	+2% Dubilier type S635	CS213D/G	K2

22  
Cont.

RECEIVER PARTS LIST (Concluded)

<u>Circuit Ref. No. Value</u>	<u>Description</u>	<u>Stores Ref. No.</u>	<u>Circuit Location</u>
C 33 (			J3
C 34 ( 5-30 pF	Erie Style 557N750	CX430F	J4
C 35 (			J5
C 36 .0013 uF	+2% Dubilier type S635	CS213D/G	K3
C 37 .0013 uF	+2% Dubilier type S635	CS213D/G	K3
C 38 100 pF	+20% Dubilier type 400	CT001/1	H6
C 39 15 pF	+5% Erie Ceramicon N750K	C415AJ	J6
C 40 3 pF	+1/4pF Erie Ceramicon NPOK	C530D	E12
C 41 30 pF	+5% LEM type 1106 (insulated)	CS430G/J	J12
C 42 300 pF	+20% Dubilier type 400	CT001/3	J15
C 43 680 pF	+5% LEM type 1106 (insulated)	CM368L/J	J15
C 44 .0013 uF	+2% Dubilier type S635	CS213D/G	K15
C 45 10 pF	+1/4pF Erie Style KA Gimmicon	C410F/J	J3
C 46 8 uF	-20% +50% 150V wkg TCC type CE134FC	CE8T/QS	K2
C 47 20 pF max.	Wingrove & Rogers type C31-14	CX421	J15
C 48 .001 uF	+20% Dubilier type 400	CT0013	K13
C 49 .01 uF	+20% Dubilier type 400	CT011	E4
C 50 .001 uF	+20% Dubilier type 400	CT0013	F5
C 51 1 uF	+100% -20% 50V wkg TCC type CE68DD	CE1T	F6
C 52 .01 uF	+20% Dubilier type 400	CT011	F10
C 53			
C 54 .001 uF	+20% Dubilier type 400	CT0013	E17
C 55 15 pF	+10% Erie Ceramicon N750K	C415AK	F4
C 56 .005 uF	+5% LEM type 2515 (insulated)	CS250G	K4



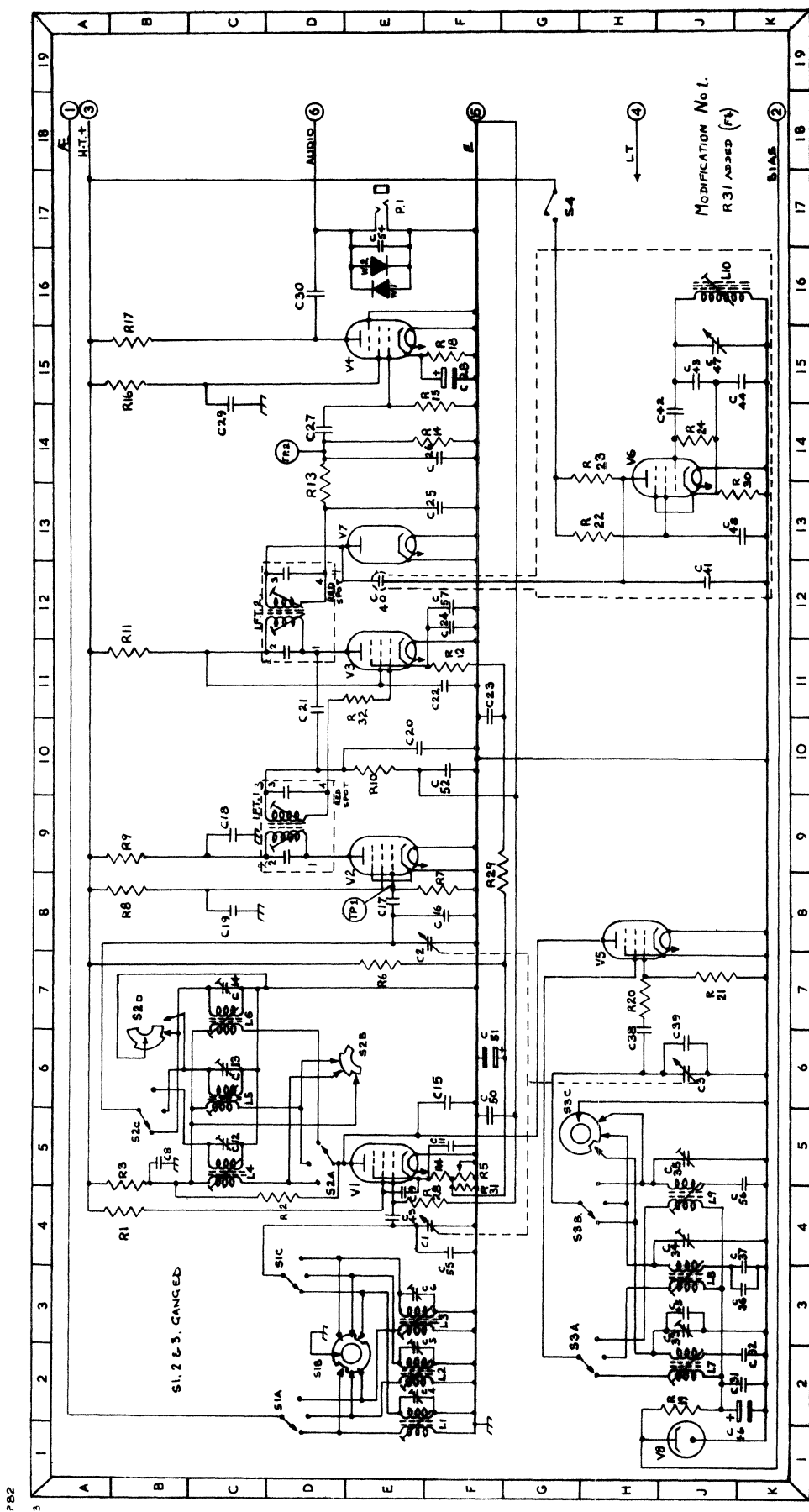

MK.123.RECEIVER - CIRCUIT DIAGRAM



TRANSMITTER PARTS LIST

<u>Circuit</u>	<u>Ref. No.</u>	<u>Value</u>	<u>Description</u>	<u>Stores</u>	<u>Circuit</u>
				<u>Ref. No.</u>	<u>Location</u>
R 1	39	Kohms	1/2watt +10% Erie type 9	R9-339K	E2
R 2	100	ohms	1/4watt +10% Erie type 16	R16-110K	G5
R 3	470	ohms	1/2watt +10% Erie type 9	R9-147K	G6
R 4	3.3	Kohms	1watt +10% Erie type 8	R8-233K	C7
R 5	10	Mohms	1watt +20% Erie type 8	R8-610M	C9
R 6	22	Kohms	1watt +10% Erie type 8	R8-322K	G8
R 7	6.8	Kohms	10watt +10% Welwyn AW3111	R52-2681K	C11
R 8	200	Kohms	2watt +10% Erie type 10	R10-420K	G10
R 9	47	ohms	1/2watt +20% Erie type 9	R9-047K	E11
R 10	19.5	Kohms	2 Off 39Kohms in parallel +10% Erie type 10	R10-339K	C12
R 11	2.2	Kohms	1/4watt +10% Erie type 16	R16-222K	J16
R 12	68	ohms	1/2watt +10% Erie type 9	R9-068K	H15
R 13	1.5	Kohms	Brimistor CZ3 +20% @ 20°C	R49-215M	J14
R 14	1	Kohms	1/2watt +10% Erie type 9	R9-210K	J14
R 15	560	ohms	1/2watt +10% Erie type 9	R9-156K	J14
R 16	180	ohms	2watt +10% Erie type 10	R10-418K	G12
R 17	18	Kohms	1/2watt +10% Erie type 9	R9-318K	E8
R 18	18	Kohms	1/2watt +10% Erie type 9	R9-318K	E8
C 1	2	uF	150V pk wkg TCC type TA12F	CE2TG	H5
C 2	15	pF	+5% Erie Ceramicon N750K	C415AJ	E6
C 3	100	pF	+10% Erie Ceramicon N750L	C310CK	F6
C 4	100	pF	+10% Erie Ceramicon N750L	C310CK	F6
C 5	330	pF	+20% Erie Ceramicon K1200K	C333	D7
C 6	1500	pF	+20% Erie Ceramicon HI-KL	C215AM	F7
C 7	680	pF	+20% Erie Ceramicon HI-KK	C368WM	C9
C 8	.01	uF	+20% Hunts 350V wkg type W99 B810	CT013J	G9
C 9	175	pF	variable Wingrove & Rogers C8/C4	C117WB/A	E9
C 10	.01	uF	TCC CP33S +25% 500V wkg	CTOSTS	G10
C 11	.01	uF	TCC CP33S +25% 500V wkg	CTOSTS	G13
C 12	470	pF	1750V wkg Erie type K1200/CD9	C347E	D13
C 13	175	pF	variable Wingrove & Rogers C8/C4	C117WB/A	G14
C 14	.5-3	pF	Erie miniature tubular trimmer 3115A	CX530	J17
C 15	47	pF	+10% Erie Ceramicon N750K	C447AK	H17

24  
Cont.TRANSMITTER PARTS LIST (Continued)

<u>Circuit</u> <u>Ref. No.</u>	<u>Value</u>	<u>Description</u>	<u>Stores</u> <u>Ref. No.</u>	<u>Circuit</u> <u>Location</u>
C 16	.01 uF	+20% Hunts 350V wkg type W99 B810	CT013J	J15
C 17	.01 uF	TCC CP45W 1000V wkg	CT019F/S	G13
C 18	.04 uF	+20% 150V wkg Hunts type W99 B858	CT041H	G4
C 19	330 pF	+20% Erie Ceramicon K1200K	C333	E12
C 20		2 turns of 24 swg tinned copper wire Suflex sleeved wrapped round lead to coil		
L 1		2.5 - 5 Mc/s	123-650	F8
L 2		5 - 10 Mc/s	123-640	F8
L 3		10 - 20 Mc/s	123-630	F9
L 4		Parasitic Stopper	123-710	E11
L 5		2.5 - 5 Mc/s	123-670	G15
L 6		5 - 10 Mc/s	123-680	G16
L 7		10 - 20 Mc/s	123-690	G17
Rect 1		CG1E BTH	RT49	H16
Rect 2		STC Uniplate H7	RT40	J15
V 1		5A/163K ST&C	CV1635	D6
V 2		CV428 ST&C	5B/251M	D12
RFC1	415 uH	121-480		F6
RFC2	2.3 mH	CH24A		C6
RFC3	400 uH	CG36		C11
RFC4	500 uH	CH37		F3
LP 1		Hivac XC15	LP95A	C9
S 1		3 pole 3 position: 2 pole shorting		E8
S 2		3 pole 4 position AB Metal Products Minibank make before break	SW31D	G15
M 1		Meter 0-500uA Hobut 400 ohms type FA	M1500BA	H14
Key		217-270		G4



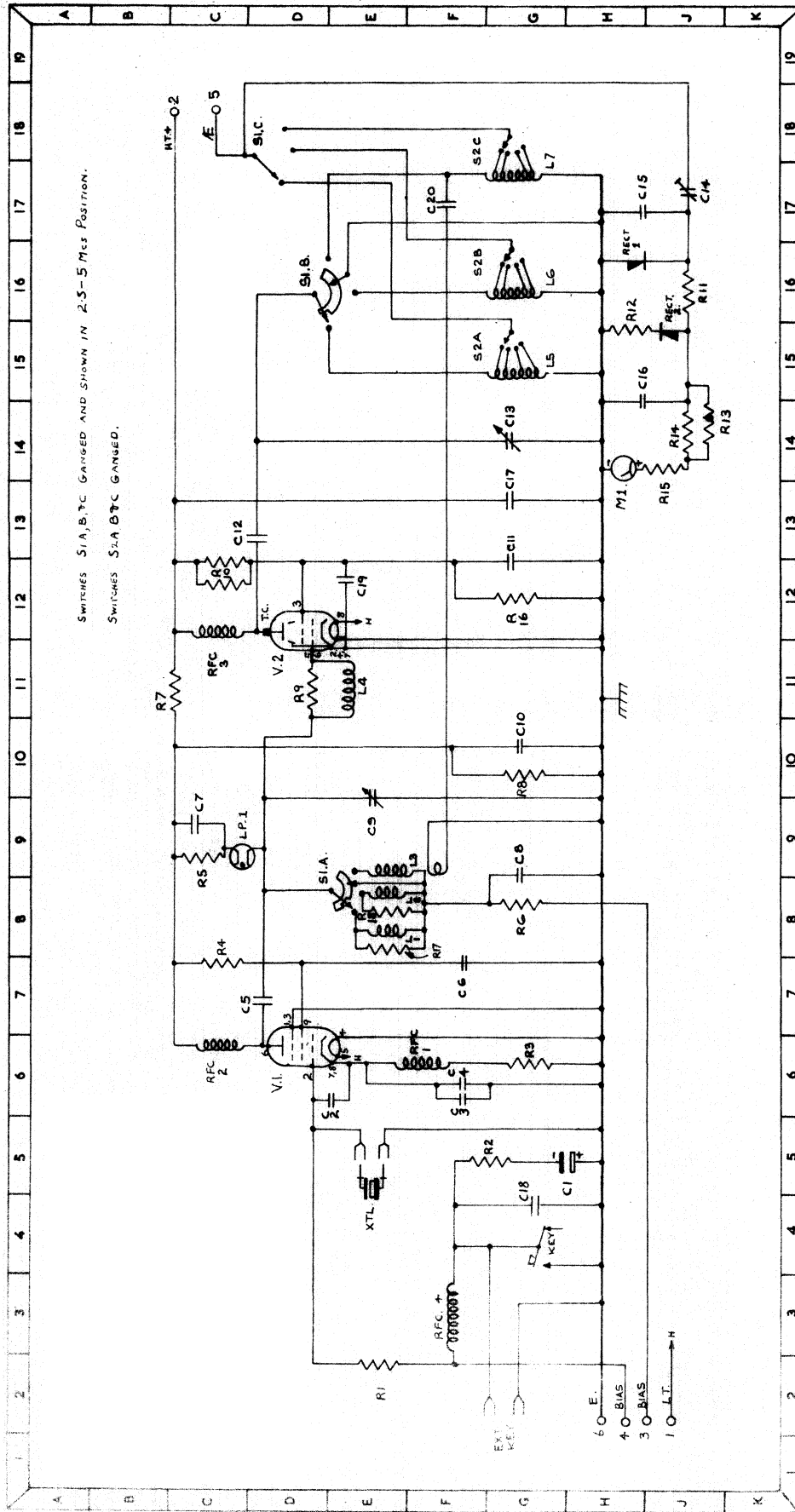

SWITCHES S1.A, B, C GANGED AND SHOWN IN 2-3-5 Mes Position.  
 SWITCHES S2.A, B, C GANGED.

**MK. 123. TRANSMITTER - CIRCUIT DIAGRAM**

POWER PACK PARTS LIST

<u>Circuit</u> <u>Ref. No.</u>	<u>Value</u>	<u>Description</u>	<u>Stores</u> <u>Ref. No.</u>	<u>Circuit</u> <u>Location</u>
R 1	2.5Kohms	10watt + 5% Welwyn AW3111	R52-225J	C3
R 2	10 Kohms	1watt +10% Erie type 9	R9-310K	D4
R 3	100 ohms	10watt + 5% Welwyn AW3111	R52-110J	E11
R 4	27 Kohms	2watt + 5% Erie type 10	R10-327J	F11
R 5	39 ohms	5watt + 5% Painton type P301	R52A-039J	E9
C 1	16 uF	Hunts JB405KZ	CE16HA	D3
C 2*	16 uF	Hunts JB405KZ	CE16HA	D10
C 3*	16 uF	Hunts JB405KZ	CE16HA	D10
C 4#	16 uF	Hunts JB405KZ	CE16HA	E10
C 5#	16 uF	Hunts JB405KZ	CE16HA	E10
F 1	4 amp	Belling Lee No. L562	FC4M	E6
T 1		0-80-236 Transformer T420U		C7
S 1		4 pole 2 position AB Metal Products type LO	SW421E	C5
S 2		Voltage Selector Switch Fortiphone	TX1514	E7
P 1		McMurdo Micronector Plug MP18	P1817	H7
Rect 1	)	Texas Instruments 1S005 (preferred)	RT54	D9
Rect 2	)	Autom Man. Co. 1N445 (alternative)	RT54	E9
TB 1		6-way tag board Prestware	550A059	E11
TB 2		6-way tag board Prestware	550A059	E3
* #	) )	The capacity of each pair of capacitors (C2/3 and C4/5) should be within +20%		

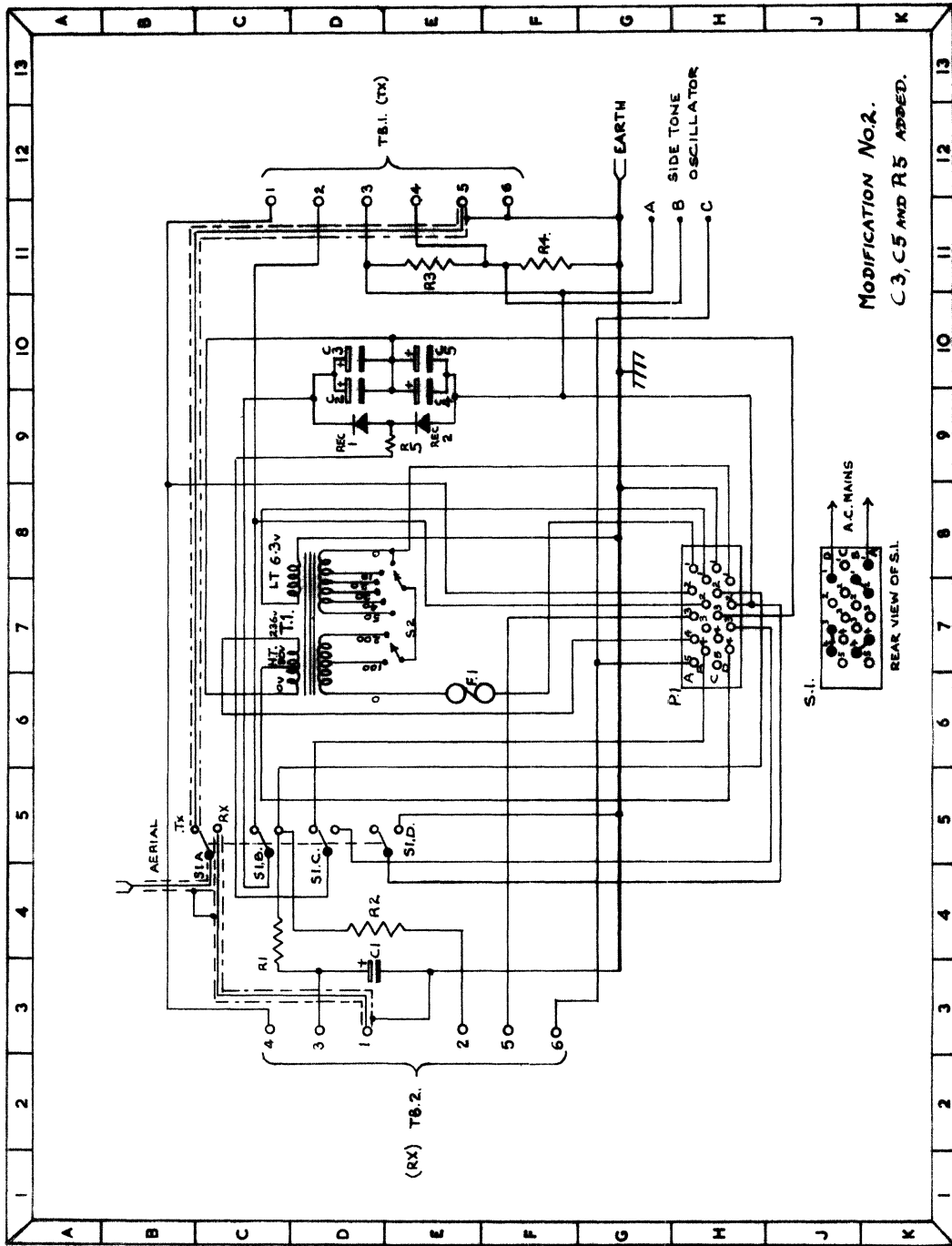

MODIFICATION No.2.  
C.3, C.5 AND R.5 ADDED.

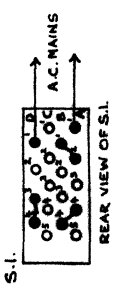

**MK.123. POWER PACK - CIRCUIT DIAGRAM**

COPY OF DEC 123/405 SMT.1 1956-4.

CONDENSER RE-FORMER CIRCUIT

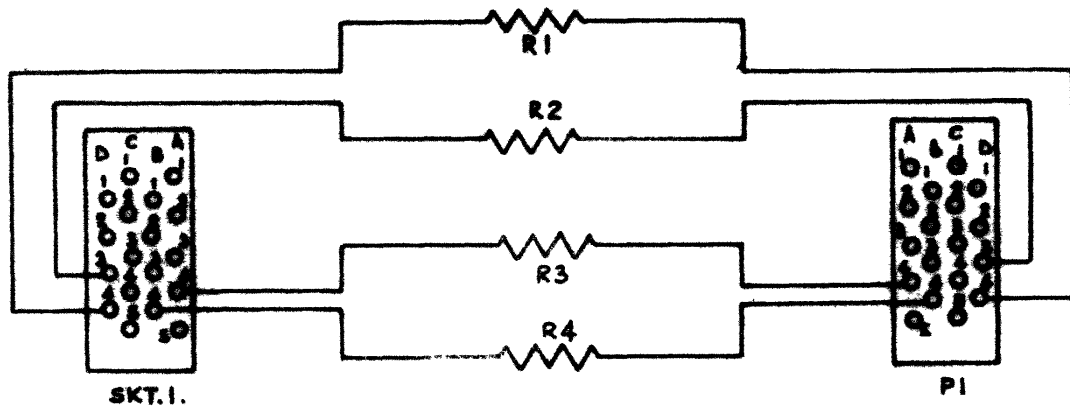

Connections between pin D3 on Plug and Socket to be as shown  
 Connections between pin D4 on Plug and Socket to be as shown  
 Connections between pin A4 on Plug and Socket to be as shown  
 Connections between pin B4 on Plug and Socket to be as shown  
 Pin B4 on Plug and Socket to be unconnected  
 All other pins on Plug to be connected to corresponding pins on Socket  
 (to avoid confusion these connections are not shown)

SKT1	18-way Micronector Socket	McMurdo MS18	P1867
P1	18-way Micronector Plug	McMurdo MP18	P1817
R1	Resistor 4.7 Kohm	+ 10% Erie Type 8	R81247K
R2	Resistor 4.7 Kohm	+ 10% Erie Type 8	R81247K
R3	Resistor 10 Kohm	+ 5% 3.5W Elcom Type 25420	R58B/310J
R4	Resistor 10 Kohm	+ 5% 3.5W Elcom Type 25420	R58B/310J

29

MK. 123 RECEIVER TEST PROCEDURE

29.1

Equipment Required

Signal generator covering the following frequencies:-  
465 kc/s; 2.5 to 21.0 Mc/s.

DC VVM 0-10V; I.P. impedance greater than 10M ohm.

AC VVM 0-1V; 0-5V. I.P. impedance greater than 1 M ohm,  
peak indicating, calibrated R.M.S.

AF Source, providing 10 mV; 100 mV; 1V at 1 kc/s Output  
impedance less than 1000 ohms.

High impedance or Amplivox phones type E5A2K according  
to test conditions.

20,000 ohms resistor dummy load.

NOTE:- Test Point - T.P.1. is the mixer valve grid (V.2)  
Circuit Ref. E.8.

Test Point T.P.2. is the junction between R13 and  
C.26 Circuit Ref. D.14.

29.2

A.F. Gain

Gain control set to minimum. AF source connected to  
TP.2. AC. V.V.M. connected across 20,000 ohm resistor  
which constitutes the only receiver output load.

Measured at 1 kc/s	A.F. Input to TP.2.
I. P.	O. P.
10 mV	0.15 - 0.3 V
100 mV	0.75 - 1.5 V
1.0 V	1.15 - 1.75 V

29.3

I.F. Gain

Gain control maximum. B.F.O. off. Signal generator  
set to 465 kc/s, CW and connected to T.P.1. directly via a  
0.01  $\mu$ F capacitor. DC. V.V.M. connected to T.P.2.

Adjust I.F. transformer cores for maximum output.

29.3 Cont. The input required for 5V. D. C. output at TP.2, should be within 50 - 100  $\mu$ V. The local oscillator remains operative.

29.4 I. F. Bandwidth

The overall bandwidth should be 5 kc/s.  $\pm$  200 c/s at - 3 dB.

29.5 B. F. O.

B. F. O. switched on. Set B. F. O. tuning control to mid position. RF signal applied as in section 29.3. Adjust core of L. 10 for zero beat.

The D. C. voltage obtained at TP.2. due to the B. F. O. should be from 1.5V to 3.5V.

The frequency range provided by the tuning control should be from  $\pm$  9 to  $\pm$  11 kc/s.

29.6 R. F. Sensitivity

Apply unmodulated RF signal to aerial terminals via 200 ohm resistor. DC. VVM connected to T. P. 2. B. F. O. switched off.

Set band switch to 2.5 - 5.0 Mc/s range.

Align oscillator and RF cores at L. F. end and trimmers at H. F. end for maximum output on D. C. VVM.

Note R. F. input required for 5V DC at T. P. 2. and also the image ratio at 2.5; 3.5 and 5.0 Mc/s.

Set band switch to 5.0 - 10.0 Mc/s range. Align at 5.0 and 10.0 Mc/s.

Note the sensitivity and image ratios at 5.0; 7.0; 10.0 Mc/s.

Set band switch to 10.0 - 20.0 Mc/s range. Align the oscillator circuits at 10.0 Mc/s and 20.0 Mc/s. Track the

29.6 R.F. circuits at 11.0 and 18.0 Mc/s.

Cont.

Note the sensitivity and image ratios at 10.0; 11.0; 14.0; 18.0 and 20.0 Mc/s.

The following R.F. input fed to the aerial socket via 200 ohms should give 5V DC at TP.2.

Band	Frequency	Sensitivity	Image Ratio Greater Than
2.5 - 5.0 Mc/s	2.5 Mc/s	3.0 - 6.0 $\mu$ V	50 dB
	3.5	3.5 - 7.0	45
	5.0	4.0 - 8.0	40
5.0 - 10.0 Mc/s	5.0 Mc/s	6.0 - 12.0 $\mu$ V	40 dB
	7.0	7.5 - 15.0	30
	10.0	9.0 - 18.0	25
10 - 20.0 Mc/s	10.0 Mc/s	15.0 - 30.0	30
	11.0	15.0 - 30.0	30
	14.0	20.0 - 40.0	25
	18.0	20.0 - 40.0	20
	20.0	30.0 - 60.0	12

30                    MK. 123 TRANSMITTER TEST PROCEDURE30·1            Equipment Required

R. F. output power meter, range 0-30 watts, impedance 500 ohms. Crystals of the following frequencies: 2·5 Mc/s; 3·0 Mc/s; 5·0 Mc/s; 6·5 Mc/s; 10 Mc/s.

Crystal socket adaptor.

Crystal current meter.

Milliammeters to read 0·5 mA and 0·150 mA.

Morse Key.

30·2            Oscillator Alignment

Short out P. A. tuning condenser, C.13.

Switch to Band 1. Using crystal frequencies 2·5 Mc/s and 5 Mc/s, adjust the core of L.1 so that these frequencies can be tuned through by means of the oscillator tuning condenser, i. e. the band edge frequencies should not coincide with either maximum or minimum setting of the condenser. Resonance is indicated by maximum brilliance of the neon, LP. 1. and by maximum reading on the meter inserted in series with the P. A. grid lead, i. e. in series with the Tag 3 lead.

Repeat the above for bands 2 and 3 using crystal frequencies 5 Mc/s. and 10 Mc/s. for band 2, and 10 Mc/s. for band 3.

30·3            Aerial Tuning Meter

Switch to Band 2 and insert 10 Mc/s. crystal. Remove short circuit from P. A. condenser. Switch aerial tap to high impedance position No. 4. No aerial load. Tune oscillator for resonance and P. A. for maximum reading on aerial tuning meter, set C. 14 for full scale reading. (C. 14. is adjusted by a screwdriver on the 4 BA round head screw situated under the morse key).

30·4            Power Output

Insert 500 ohms. dummy aerial into the aerial socket on the contact cradle.



30.4 Check the power output; crystal current and P.A. grid drive  
 Cont. current on the following frequencies:-

Band 1. 2.5: 3.0: 5.0 Mc/s. Xtal Fundamental  
 2. 5.0: 6.5: 10.0 " " "  
 and 10.0 Mc/s. using the second harmonic of 5.0 Mc/s. Xtal.  
 Band 3. 10.0 Mc/s. Xtal fundamental: 13.0 & 20.0 Mc/s.  
 using the second harmonic of 6.5 and 10.0 Mc/s.

Check that output is obtained on all position of the aerial tap switch.

Band	Crystal Current mA	Grid Drive mA	Power O.P. Watts
1	10 - 30	2.0 - 3.0	19 - 30
2	10 - 30	1.5 - 2.5	15 - 30
3	10 - 30	1.0 - 2.5	15 - 25

Tap 3 on the aerial switch gives the best match for 500 ohm load at all test frequencies, except 20 Mc/s. which matches on Tap 2.

The aerial meter will give the following readings at full output:-

Band 1. Greater than 290  $\mu$ A.  
 2. " " 300  $\mu$ A.  
 3. " " 300  $\mu$ A.

30.5 Voltage & Current Measurements

The meter should be a 20,000 ohm. volt instrument.

The keyed condition is with the transmitter operating at 10 Mc/s; fundamental Xtal frequency; Band 2; with 500 ohm. aerial load.

30.5  
Cont.

	<u>Keyed</u>	<u>Unkeyed</u>
H. T. Supply Voltage	$425 \pm 15V$	$480 \pm 15V$
H. T. Current	$120 \pm 5 \text{ mA.}$	Less than 5 mA.
H. T. Ripple (A. C. V. V. M. )	Less than 50V	Less than 3.0V
L. T. A. C. Voltage	$6.1 \pm 0.15V$	$6.3 \pm 0.3V$
L. T. Current (TX and RX)		2.55 Amps
VL. Anode Voltage	$310 \pm 15V$	$465 \pm 15V$
VL. Screen Voltage	$300 \pm 15V$	$465 \pm 15V$
V1. Cathode Voltage	$7.0 \pm 1.5V$	-
Vz. Anode Voltage	$425 \pm 15V$	$480 \pm 15V$
Vz. Screen Voltage	$270 \pm 15V$	$435 \pm 15V$
Bias to V1 Grid & Power Socket	$1.4 \pm 0.2V$	$126 \pm 2V$
Bias to V2 Grid & Power Socket	$13.0 \pm 0.5V$	$126 \pm 2V$

31                    MK. 123 POWER UNIT TEST PROCEDURE31.1            Equipment Required

AC. V. V. M. (peak reading, calibrated RMS).  
AC. ammeter to read 1 amp. f. s. d.  
Variac transformer.  
DC. meter, sensitivity 20,000 ohms/volt.  
Headphones.  
Oscilloscope, with calibrated time scale.

31.2            Test Procedure

The following tests to be made on 100V and 230V.  
50 CPS. AC. input, unless otherwise stated.

The following figures were taken into a resistive load,  
but should be fairly representative of working voltages  
and currents.

31.3		100V I. P. TAP	230V I. P. TAP
	<u>AC. I. P. CURRENT</u>		
	P. U. Switched to RX.	0.40 - 0.50A	0.15 - 0.20A
	P. U. Switched to TX. -		
	TX KEYED	0.85 - 0.95A	0.35 - 0.40A
	TX - UNKEYED	0.35 - 0.50A	0.15 - 0.20A
31.4	<u>LT. VOLTAGE</u>		
	TX. Unkeyed	6.1 - 6.5V	6.1 - 6.5V
	TX. Keyed	6.0 - 6.4V	6.0 - 6.4V
31.5	<u>HT. VOLTAGES</u>		
	TX. Keyed	440 - 470V	440 - 470V
	TX. Unkeyed	440 - 470V	440 - 470V
	RX. HT. 1	110 - 120V	110 - 120V
	RX. HT. 2	103 - 113V	103 - 113V
31.6	<u>HT. RIPPLE VOLTAGES</u>		
	TX. Keyed. Not more than	15V RMS	15V RMS
	TX. Unkeyed " " "	2.0 V RMS	2.0 V RMS
	RX. HT 1. " " "	0.5 V RMS	0.5 V RMS
31.7	<u>TRANSMITTER BIAS</u>		
	Total Bias - keyed	10 - 12V	10 - 12V
	Total Bias - unkeyed	110 - 135V	110 - 135V
31.8	<u>ALTERNATIVE AC INPUTS</u>		

The LT VOLTAGE should lie within the limits.  
6.1 - 6.5V FOR ALL INPUTS 100 - 250V.

31·9 SIDETONE OSCILLATOR

Power unit switched to TX. Measure the following voltages when in the keyed condition.

D.C. voltage between A(-) and B(+)	10 - 12V
Oscillator O.P. voltage unloaded	4·0 - 7·0V
Oscillator frequency	1·0 - 2·0 kc/s

Check with headphones that the oscillator note is reasonably clean.

31·10 INSULATION

The equipment should withstand a 1,000V flash test applied between either input lead and the case.

